

SMT-i6010/6011

User Guide

The purpose of Safety Concerns is to ensure users' safety and to prevent property losses.
Please read this document carefully for proper use.



COPYRIGHT

This guide is proprietary to SAMSUNG Electronics Co., Ltd. and is protected by copyright.

No information contained herein may be copied, translated, transcribed or duplicated for any commercial purposes or disclosed to the third party in

TRADEMARKS

Product names mentioned in this manual may be trademarks and/or registered trademarks of their respective companies.

This guide may be changed for product improvement, standardization or other technical reasons without prior notice.

For further information on the updated guide or the contents contained in the guide, please contact your Authorized Samsung Reseller.

SAFETY CONCERNS

The purpose of the Safety Concerns section is to ensure the safety of users and prevent property damage. Please read this document carefully for proper use.

Conventions



Warning

Provides information or instructions that you should follow in order to avoid personal injury or fatality.



Caution

Provides information or instructions that you should follow in order to avoid a service failure or damage to your phone.



Note

Indicates additional information for reference.



Checks

Provides the operator with checkpoints for stable system operation.

Symbols



Caution

Indication of a general caution



Restriction

Indication for prohibiting an action for a product



Instruction

Indication for commanding a specifically required action



WARNING

Power



Do not use damaged power cord or loose outlets.



Do not pull or bend the cord by force, and do not touch the power plug with wet hand.



When the phone is out of use for a long time, leave the plug pulled out of the outlet.



For the power connection port of the phone, use the provided optional power adapter. Use of a power adapter that does not meet the specifications may cause the product to become damaged, to overheat, or to explode.



If there is dirt or moisture on the pin contact surface of a power plug, pull out the plug and wipe it away with a cloth. If dirt or moisture remains on the product even after wiping, contact the service center.



If an abnormal sound, smell or smoke is emitted from the phone, pull out the power plug immediately, and then contact the service center.

Installation/Maintenance



Do not place the phone in a location with a lot of dust, in a location that is subject to severe changes in temperature, or near a heating device (cigarette heat, heater, etc.)



Do not use or store flammable spray or materials near the phone.



Do not place objects containing water such as vases, flowerpots, cups, cosmetics, or medicines near your phone. Humidity or liquid may damage the parts and circuits of this product.



CAUTION

Power



Do not power off the phone while upgrading a program.

General



The LAN cable to the network should be connected to the LAN port of a phone, NOT to the PC connection port.



Do not place a heavy object on top of the phone.



Do not drop the product or apply impact on the product. It may damage product screen or exterior and its internal parts.



Do not install the phone under direct sunlight.



Safety is not guaranteed if expendable items or additional goods are used unauthorized by Samsung.



Do not attempt to disassemble, fix, or rebuild the phone yourself.



Use a soft and dry cloth when cleaning the phone. Do not spray water directly onto the product; and do not use chemicals such as wax, benzene, alcohol, thinner, mosquito killer, perfume spray, lubricant, detergent, etc.



Listening with a headset or earphone at high volume may damage your hearing.

TABLE OF CONTENTS

SAFETY CONCERNS **1**

Conventions.....	1
Symbols	1
Warning.....	2
Caution.....	3

BEFORE USE **8**

Checking Parts in the Package	8
Phone Installation	9
Connection to Back Ports	9
Assembling the Cradle for Desk.....	11
Assembling the Wall-Mount Bracket (option).....	12

THINGS YOU SHOULD KNOW **15**

Key Functions	15
Part Names and Functions.....	17
Front Configuration	17
Name and Function	18
Phone Information Display	20
Phone Status Indicator.....	20
LED Indicator	20
Phone Status Icons.....	21
Supplementary Functions Menu	22
Usage of Supplementary Functions Menu	22

Text Input Method	23
-------------------------	----

BASIC FUNCTIONS **24**

Easy Installation.....	24
Dialing	27
Dialing an Extension Number.....	27
Dialing a Outbound Call.....	28
Dialing via Speaker Phone	29
Dialing the Last Call Number.....	29
Answering Incoming Calls	30
Receiving a Call via the Handset	30
Receiving a Call via Speaker Phone.....	30
Functions Available during Call	31
Call Park.....	31
Mute	31
Call Transfer.....	32
Conference Function	33
Details (Premium CID).....	33
Call Move	34
Volume Control	35
Volume Control of a Handset	35
Volume Control of a Speaker.....	35
Volume Control of Ringing Sound.....	36

HOW TO USE MENUS **37**

Menu Structure	37
Contacts	39
History	42
Message	43

Language	47
System Options	47
Call Transfer	47
Absent Message	47
Call	48
Phone Name	48
Station On/off	48
Extension Login	48
AOM	49
Settings	50
Sound	50
Screen	51
Security	52
Bluetooth & Headset	52
User Data Initialization	57
Setting Wi-Fi 5G Only	57
Phone Information	58
Version Information	58
Network information	58
Deskphone Manager Connection Information	58

INTEROPERATION SERVICE

59

Smart Phone Interoperation (SDM)	59
System Configuration Diagram	59
Key Functions	60
Registration Methods	60
Deregistration	65
Dashboard	66
Contacts	67
Call Log	77

Program Key	79
Settings	82

TROUBLESHOOTING	85
------------------------	-----------

ANNEX	87
--------------	-----------

Product Specifications.....	87
-----------------------------	----

BEFORE USE

Checking Parts in the Package



Phone Body



Handset

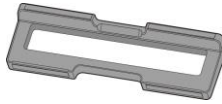

Phone Cradle



Quick Guide



LAN Cable



Power Adaptor
(option)

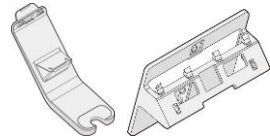

Wall-Mount Bracket (option)



- If any components are damaged or missing, contact the dealer.
- The Power Adaptor and Wall-Mount Bracket are options. If necessary, contact the dealer.

Phone Installation

Connection to Back Ports

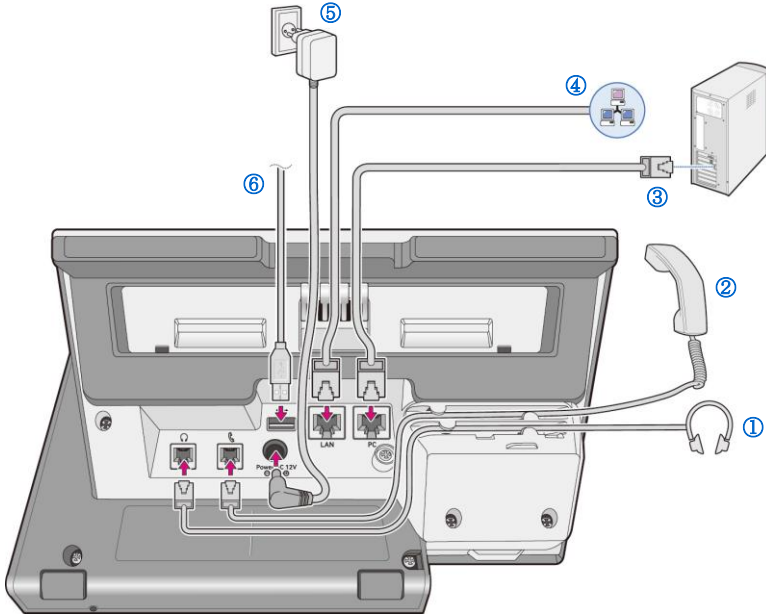

BEFORE USE

1 If a headset is used, connect it to the **headset port**.

2 Connect a handset to the **handset port** of the phone.

3 Connect one end of the PC connection LAN cable, which was provided with the phone, to the PC connection port of the phone. Connect the other end to the PC network port.

4

Connect the LAN cable connected to the network to the LAN connection port of the phone.

- When power is supplied from the LAN port (PoE), the phone is booted upon LAN connection.

5

If PoE is not supported, connect the power adapter to the **power connection port**. When the plug of the connected power adapter is plugged into the outlet, the phone is booted up. (The power adapter is purchased separately.)

- When connecting the power cable, make it go through the center hole of phone cradle.

6

If a USB is used, connect a USB to the USB connection port.

Assembling the Cradle for Desk

The installation angle of a phone can be changed depending on the assembly direction of the cradle.

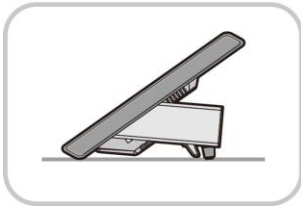
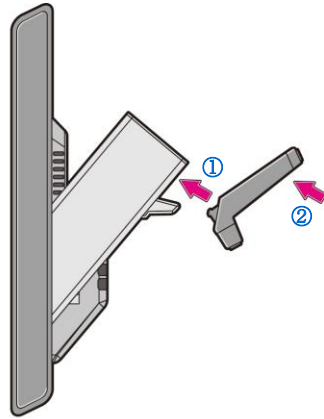
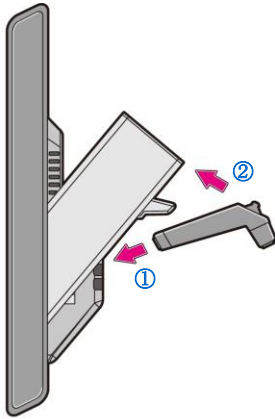

1 Fix one latch of the cradle to the top or bottom groove of the phone.

2 Push the remaining latch into the remaining groove on the opposite side.

3 Place the phone on the installation location and check whether it shakes.

Assembling the Wall-Mount Bracket (option)

Assemble the wall-mount bracket where you want to use the phone.

The wall-mount bracket is an optional item. If necessary, please contact your dealer.

- 1 Place the wall mount bracket installed on the wall, and mark two screw holes and drill it.

- Use one of two bottom holes.

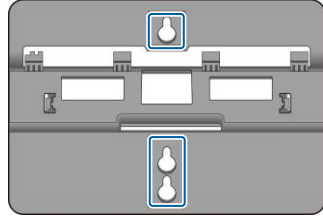

- 2 Insert the 2 plastic anchors in a hole in the wall with mallet, and fix with enclosed screws.

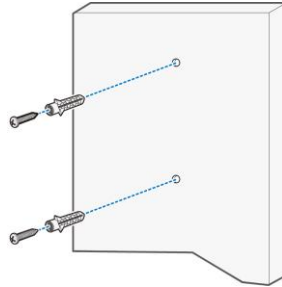

- 3 Handset bracket and wall mount bracket are fixed to the body as shown below for the order.

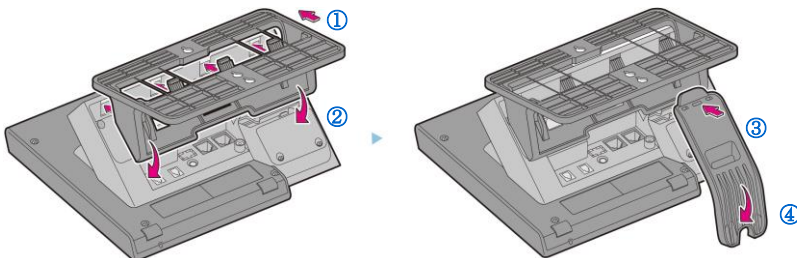

- 4 Insert the wall-mount bracket as shown in the figure.

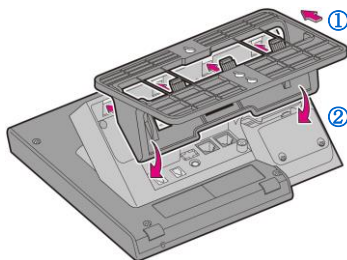

- 5 Extract hanger part which placing the handset in the body with a flat-blade screw driver and re-insert it a 180 degree turn.
- This prevents the handset falling.

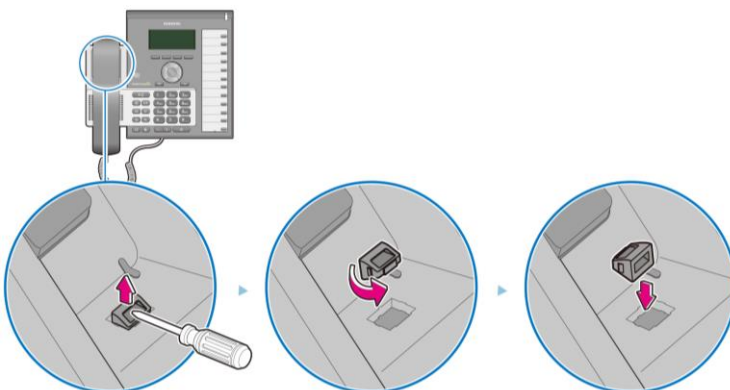

6

Attach to match wall mount bracket hole and screws, and pull down to make sure firmly fixed.

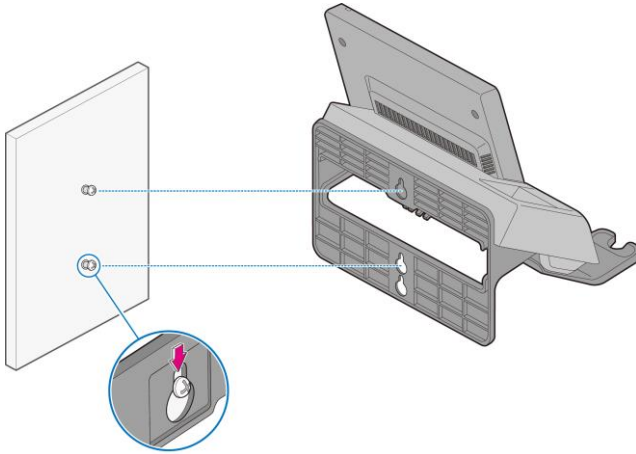

THINGS YOU SHOULD KNOW

Key Functions

IP Network



The SMT-i6010/6011 phone enables voice telecommunication through an already-installed data network, without requiring the installation of an additional telephone line. Therefore, it does not require the additional expense of maintaining telephone numbers, and can save on telephone costs for the businesses, and people, that use international phone calls frequently.

Bluetooth Headset



A user can talk to a counterpart by connecting a wireless Bluetooth headset to the phone.

Bluetooth Smart Phone Mode



Connect the phone and a smartphone via Bluetooth, then you can use the phone to take the call received to the smartphone and you can also use the call move function.

Call Park



If you must interrupt a call, you can put the call on hold or transfer it to another person using the Call Park or Call transferring function.

Conference



During a call, you can have a conference call with others by pressing the **[Conference]** button.

Call Forward

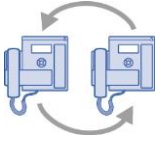

A call can be forwarded to another number when the call cannot be received.

DND



If this function is selected, the phone does not ring even when a call is placed to the phone.

USB Charging

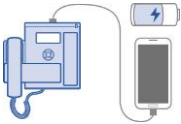

With a phone to which a power adaptor is connected, you can use the USB charging function. (When PoE is connected, the USB charging function is not available during call.)

Part Names and Functions

Front Configuration

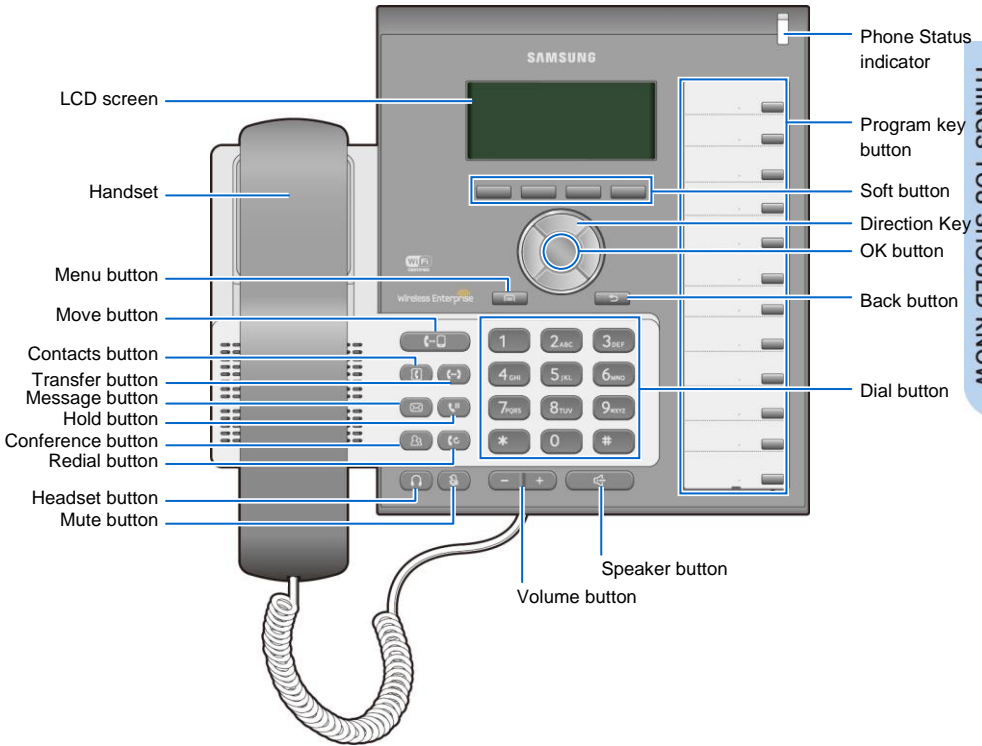

The color or image of the product in this manual may be different from the actual ones.



Handset placing part contains magnetic material to hold handset, so do not leave things which should not receive the influence of the magnetic material.

Name and Function

Button	Function
Phone Status Indicator	A LED shows the phone status (busy, ringing, receiving an internal message, etc.).
Soft button	This button is used to select desired function from the menus displayed on the LCD screen.
Direction key	This button is used to edit the contents on the screen or move between menu items.
OK button	This button is used to select/save an item where a cursor is located in the menu status or to check the caller information from an outbound line while receiving an incoming call.
Back button	This button moves to a previous item.
Menu button	This button displays menu items.
Headset button	This button is used to talk using a headset
Volume button	This button is used to control the volume of the handset, speaker, key tone, etc.
Mute button	This button silences the voice of the user to the called party.
Speaker button	This button is used to converse via a speaker phone instead of a handset.
Dial button	This button is used to enter numbers and characters.
Program key button	You can assign a frequently used function to each button. When you press a specified button, the assigned function is executed. For details about how to set this function, contact the administrator.
Conference button	This button is used to make a conference call by calling other subscribers during call.
Message button	This button displays the message menu.
Contacts button	This button displays the contact menu.
Hold button	This button is used to hold a call temporary without hanging up.
Transfer button	This button is used to transfer a call to someone else.
Move button	If a UE is connected to a smartphone via FMC subscriber, NFC or Bluetooth (smartphone mode), a call can be switched between connected devices using the Move button.
Redial button	This button is used to call a previous number.

Button	Function
LCD screen	<p>The configuration of LCD screen is as follows:</p> <ul style="list-style-type: none"> - On the top of the screen, the icons representing phone function settings are displayed. - On the main screen, selectable menus, the call processing status, or various messages are displayed. - On the bottom of the screen, soft menus are displayed.
Handset	Handset transfers the caller's voice.

Navigation button

The i6010/6011 phone has navigation buttons that allow users to use its functions easily.

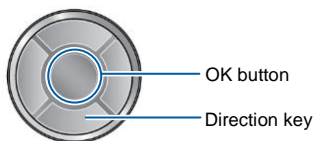

Button		Function
Navigation	Direction key	This button is used to edit the contents on the screen or move between menu items.
	OK	<ul style="list-style-type: none"> - This button is used to select or save the item where a cursor is placed in a menu mode. - This button is used to check the caller information received from an outbound line during receiving.

Phone Information Display

Phone Status Indicator

Indicator light is turned on or off depending on the phone status.



Situation	Indicator status
In a call	Red indicator light stays on.
When there is an incoming ringing	Red indicator light blinks.
When a voice message is left	Red indicator light blinks.







LED Indicator

The below button LED is turned on or off depending on status.

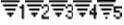
Button LED	LED Status	Description
Speaker	Red indicator light turns on	When a speaker phone is used.
Mute	Red indicator light turns on	When all voice sending is blocked.
Headset	Red indicator light turns on	When a call is made via a headset.
Program Key	Blinks fast in red (0.3 sec.)	When the user is receiving an incoming call.
	Blinks slowly in red (2 sec.)	When the user is on hold.
	Red indicator light turns on	A user is busy or the corresponding function is enabled

Phone Status Icons

Icon shows the phone setting status, being displayed on the right top side.

Icon	Description
	Signal intensity of wireless network
	Types of headset in use (general/EHS/Bluetooth)
	Bluetooth headset
	Bluetooth mobile phone
	Smart phone connection status
	AOM connection status (Galaxy Tab 10.1)
	Lock status

Supplementary Functions Menu

Supplementary functions menu is a user convenience function available per phone conditions.

It is provided via interworking with the system, and displayed as a menu on the right side of a screen.



Supplementary functions menu varies depending on system version.

Usage of Supplementary Functions Menu

While pressing the **[Function]** soft button at the bottom of screen, press the right selection button of the menu you want to use.

Supplementary Functions Menu of Waiting Screen

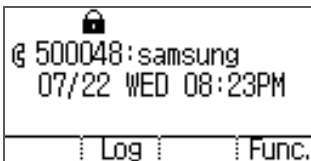

Supplementary Functions Menu of Communication Status

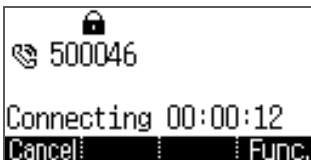

Text Input Method

Using the dial buttons and navigation buttons on the phone, the user can easily enter or modify the Korean, English, numbers, and special characters.

- 1 Whenever the user presses the dial button [*] on a text input screen, the input mode is changed in sequence. The input mode status is displayed as an icon in the status area of the top-right corner of the LCD.



- A English input mode-uppercase
- a English input mode-lowercase
- 1 Numeric input mode
- \$ Special character input mode

- 2 Alphabet and numbers can be input using the dial buttons.
- Inputting special characters: Press the [*] button to select the special character input mode, and select characters using the navigation button to input or modify them.

Navigation button



Dial button



BASIC FUNCTIONS

Easy Installation

In the phone initialization status, a user can easily register to the system.



If incorrect information is entered during easy installation, the phone may not be properly registered or there may be a network fault. Make sure to enter the information provided by the system administrator.

The SMT-i6010/6011 phone supports 2 types of phone registration.

Settings	Description
Server	A phone is registered by using the information from the environment server.
PnP (Plug & Play)	A phone is automatically registered if the system supports PnP. - To use the PnP function, a system administrator must configure an environment for PnP in advance. Contact the administrator to check whether the PnP environment is configured.

- 1 When the power is connected during initialization status, the **[Easy Install]** soft menu is displayed at the bottom of screen. Start easy installation by pressing the **[EASY]** soft button.

- In the phone initialization status, the default language is English.

- 2 After selecting a language to use for the phone, press the **[Next]** soft button.

- When the phone is connected to the system after easy installation, the language may be changed depending on the administrator's settings.

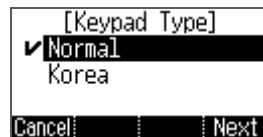

- 3 After selecting the setup method, press the **[Next]** soft button. Depending on the selected setup method, the easy installation step is changed.

- Select one out of Server/PnP.
- Server: Input Server address, phone id and select system type
- PnP: If you can use PnP environment, select PnP.



- 4 Enter the network information.

When the setup method is **[Wired]**

- Select one out of DHCP/Static/PPPoE.
- Make sure to contact the system administrator because network connection may be failed if incorrect information is entered.



When the setup method is **[Wireless]**

- When Wi-Fi is selected, nearby APs are automatically searched.
- Wi-Fi is working properly when the AC adaptor is connected.
- After selecting an AP to connect in the searched list, connect to it in the STATIC or DHCP mode.

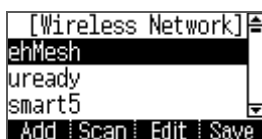
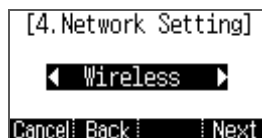

[Wireless] function is supported SMT-i6011 only.

5

Enter the VLAN information.

- Make sure to contact the system administrator because network connection may be failed if incorrect information is entered.



```
[5. VLAN-Phone]
VLAN : Use
VLAN ID : 2
Priority: 0
Cancel: Back | Next
```

6

Enter the 802.1x information and press the **[Next]** soft button.

- Make sure to contact the system administrator because network connection may be failed if incorrect information is entered.



```
[7. 802.1x Setting]
802.1x ID+PW
ID :
Password:
Cancel: Back | Next
```

7

After configuring LLDP, Complete easy installation by pressing the **[Done]** soft button, then the phone is restarted.

- To modify already entered information, select **[No]** and press the **[<]** soft button.



```
[8. LLDP]
Mode : Not Use
Cancel: Back | Next
```

Dialing

This section describes how to make a call to an extension number or outbound number.



An extension line is the telephone line through which a call can be placed to another internal phone connected to the system of the office. An outbound line is the telephone line where the user can make or receive a call to/from outside (e.g. home), which is directly connected to the switching system of a central office.

Dialing an Extension Number

- 1 Pick up the handset, check whether the dial tone is audible, and then press the extension number.



- 2 When you press the extension number, you can hear a call connection tone.

- 3 If the other party receives the call, begin the conversation.



Dialing a Outbound Call

- 1 Pick up the handset, and check whether the dial tone is audible.

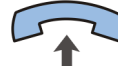

- 2 Press a key specified by the manufacturer to make an outbound call (e.g. '9')

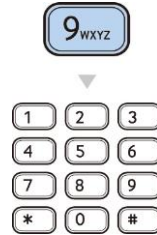

- 3 When you dial a number, you can hear a call connection tone.

- 4 If the other party receives the call, begin the conversation.



NOTE

As the outbound call number may vary per system, contact the system administrator.

Dialing via Speaker Phone

- 1 Press the **[Speaker]** button without picking up a handset.



- 2 Press a phone number, then you can hear a call connection tone.

- 3 Start the conversation when the other party answers the phone.
- If the handset is picked during a call, the speaker is turned off, and the conversation can be continued through the handset.

- 4 When a call ends, press the **[Speaker]** button again.
- If a handset is being used, hang up.



Dialing the Last Call Number

- 1 When you press the **[Log]** soft button at the bottom of waiting screen, the recent call log is displayed.

- 2 Move to a phone number you want by using the navigation button.
And press the **[Call]** soft button, then a call is made to the selected number.

Answering Incoming Calls

This section describes how to answer a call.

Receiving a Call via the Handset

- 1 Pick up the handset when a phone rings.



- 2 Converse with the counterpart.



- 3 Hang up the handset when the call ends.



Receiving a Call via Speaker Phone

- 1 When the phone rings, press the **[Speaker]** button.

- 2 Converse with the counterpart.
- If the handset is picked during a call, the speaker is turned off, and the conversation can be continued through the handset.
- 3 When a call ends, press the **[Speaker]** button again.



Functions Available during Call

The functions below are convenient to use while making a call via an extension or outbound line.

Call Park

A call can be held temporarily to make the caller wait, and then the conversation can be continued when convenient.



Operation may vary depending on your system. For more information, contact your system manager.

1

To hold the current call, press the **[Hold]** button during call.



2

The 'Hold' message is displayed.

- If **Speaker mode**, waiting screen is displayed.
- The call can be resumed by pressing the **[Program key]** → **[Resume]** soft button again.

Mute

This function is used to silence the user's voice during a call via an extension line, but the user can still hear the voice of the other party.

1

To block your voice during call, press the **[Mute]** button.

- Now the counterpart cannot hear your voice.
- The LED of **[Mute]** button is turned on.



2

When you press the **[Mute]** button again, the function is cleared.



Call Transfer

A current call can be transferred to another extension or outbound line's subscriber.

1

To transfer a call, press the **[Transfer]** button.



2

After hearing a dial tone, dial the phone numbers of the other conference participants.

- If you need to transfer a call to a phone number in an outbound line, enter the outbound call number first and then enter the phone number.

3

When a ring back tone is heard from the other subscriber, put down the handset.

- Alternately, wait until the called party receives the call, and then hang up the phone after telling him/her about it.

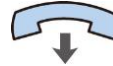

If the subscriber who received a transferred call is busy or does not receive the call:

To return to the original call, press the **[cancel]** button. Then you can retry by press the **[Transfer]** button again to retry, or, return to the existing call by pressing the **[Hold]** button.

Conference Function

During a call, other subscribers of extension line can be invited to participate in a conference call.

1 Press the **[Conference]** button during a call.

- If the system does not support the conference function, the conference call is not available.



2 After hearing a dial tone, dial the phone numbers of the other conference participants.

3 When a call is connected, start to talk by pressing the **[Conference]** button.

- You can add a subscriber in the same manner during conference call. (To know the maximum number of conference participants, contact the system administrator.)



If this function does not work properly, contact the system administrator.

Details (Premium CID)

Displays the counterpart's information on the screen during communication.

When the information is received, the counterpart's detail information is displayed on the screen.

```
Name :SMT-15243
Job  :Engineer
Corp :Samsung
Div. :Network I/In
      :Back
```



If system does not support, this function does not work. Contact you system manager.

Call Move

You can move a call back and forth between the IP phone and mobile phone.

When IP phone is connected with smart phone's bluetooth headset, a call can be transferred from IP phone to smart phone using system function and bluetooth function.

1 Go to **[Menu]** → **[Settings]** → **[Bluetooth & Headset]** → After setting the **[Bluetooth Mode]** to the smartphone, connect your smartphone to the IP phone.

- For more information about how to setup, refer to the 'Bluetooth & Headset' part of this manual.

2 During communication using the IP phone, if you press the **[Move]** button, you can still talk through the smartphone.

- Operation may vary depending on call type.

3 During communication using the smartphone, if you press the **[Headset]** button, you can still talk through the IP phone.

- Operation may vary depending on smart phone. Refer you smart phone user's manual.





This function is supported for 6011 model only.



Volume Control

The user can adjust the volume of a handset, speaker and tone sound.

Volume Control of a Handset

- | | | |
|---|--|---|
| 1 | The user can adjust the volume in the following way while making a call via a handset. |  |
| 2 | To increase the volume of a handset, press the (+) of the [Volume] button. |  |
| 3 | To decrease the volume, press the (-) of the [Volume] button. |  |

Volume Control of a Speaker

- | | | |
|---|---|---|
| 1 | The user can adjust the volume of a speaker in the following way while calling. | |
| 2 | To increase the speaker volume, press the (+) of the [Volume] button. |  |
| 3 | To decrease the speaker volume, press the (-) of the [Volume] button. |  |

Volume Control of Ringing Sound

1

To increase the volume of the ringtone, press (+) of the **[Volume]** button while the bell is ringing.

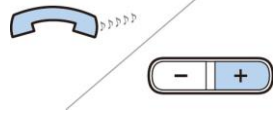

2

To decrease the volume of the ringtone, press the (-) of the **[Volume]** button while the bell is ringing.

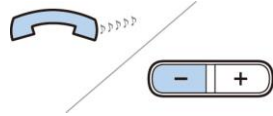

By pressing the **[Volume]** button in standby mode, the user can also adjust the key tone volume.

HOW TO USE MENUS

This section describes menu functions. Call, phone, and setup are displayed as a menu.

Menu Structure

Clicking the **[Menu]** soft button when a phone is in standby mode displays menus on a screen. The desired menu can be selected by using the navigation button or the selection button on the right side of screen or the soft button at the bottom of screen.



Function with mark(*) may vary or does not supported depending on your system.

Menu	Sub-menus	Function
Contacts	-	This function provides save, search and registering function of the phone address book. You can search for a user registered in the directory server.
History	-	You can check the recent outgoing/incoming history.
Message	-	You can write and save a message.
Language	-	You can search and use the information provided from the browser server.
System Option	*Call Forward	You can set call forward type.
	Absent Message	If you can not receive calls then sends a message to caller..
	Call	You can set call functions provided by system.
	Phone Name	You can set Phone Name.
	*Station On/Off	You can set Subscriber functions provided by system.
	*Extension Login	You can enable or disable Extension Login.
	AOM	You can set and check AOM Key.
Settings	Sound	You can select various bell sounds and button sounds and adjust the sound volume.
	Screen	You can change date, time, font, LCD power.

Menu	Sub-menus	Function
	Security	You can change the password, and lock the phone, so that other people cannot use their phone.
	Bluetooth & Headset	You can set up a headset.
	User Data Init	You can initialize the user data.
	Wi-Fi 5G Only Set.	You can enable or disable Wi-Fi 5G Only mode.
Phone Information	Version Information	You can check the phone version.
	Network Information	You can check the network setting information of the phone.
	SDM information	You can check registered external device, and register or cancel registration.

Contacts

[Phone Contacts]

Using the contacts, the user can easily manage phone numbers, email ID, fax numbers, and photos, etc. In addition, calls can easily be made using the contacts.

Viewing a Phone Number

You can view the phone number saved in the contacts.

- 1 Select **[Menu]** → **[Contacts]**.
And select a group you want.



- 2 The list of saved phone numbers is displayed.
When you select a target and press the **[OK]** button, the detail information is displayed.
- **[Call]**: You can make a call to the selected phone number.

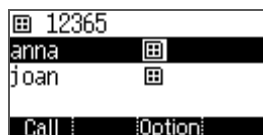

Search Phone Number

You can search a phone number saved in the contacts by using a name or number.

- 1 Press the **[Menu]** → **[Contacts]** → **[Search]** soft button.



- 2 Enter a name or phone number and press **[OK]** button to display a list of the searched phone numbers.
- You can search the number by entering just a part of the name to search.
- After selecting a name in the search list, press the **[OK]** button. Then, the detail information of



phone number is displayed.

Adding a Phone Number

The phone numbers of up to 300 people can be saved.

- 1 Press the **[Menu]** → **[Contacts]** → **[New]** soft button.



- 2 Enter the name and phone number information, etc. and press the **[Save]** soft button.

- You can set up the numbers (company, mobile phone, home, fax, others), e-mail, memo, bell sound, buddy ID and register photos.



- 3 Pushing **[+]** button to save phone number, Email, Memo.

- Select menu you want and press **[OK]**.
You can save max. 10 phone number (Office, Mobile, Home, Fax), max 3 Email, max 1 Memo.

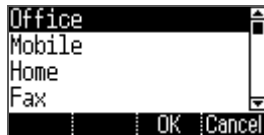

Editing Contacts

You can edit a phone number registered in the contacts.

- 1 Press the **[Menu]** → **[Contacts]** → **[Search]**, select a phone number to edit, **[OK]** → **[Edit]** soft button.

- 2 Enter the modified information and press the **[Save]** soft button.

Deleting Phone Number

You can delete a phone number registered in the contacts.

1 Go to **[Menu]** → **[Contacts]**, Select a group, press **[Option]**, select a phone number to delete and press the **[Del]** soft button.

2 Click the **[Delete]** soft button to delete the phone number.

Add Group

This is the function used to add a new group.

1 Press the **[Menu]** → **[Contacts]** → **[Option]** → **[New]** soft button.



2 Enter a new group name and press the **[Save]** soft button.



Delete Group

This is the function used to delete an existing group.

1 Go to **[Menu]** → **[Contacts]** → **[Option]** → select a group to delete and press the **[Del.]** soft button.

2 Click the **[Yes]** soft button to delete the phone number.
- The members of the deleted group are moved to the unspecified group.

History

The recently incoming/outgoing calls, incoming calls during absence are displayed. Up to 300 records can be saved.

Select **[Menu]** → **[History]**. You can move to Total, Outgoing, Incoming, Absence number list.

- **[Save]**: You can save selected number to phone book.
- **[Call]**: You can call the selected number.
- **[Option]**: You can delete history of selected number of all.
- If selected number is saved to phone book, you can view detail information by pushing **[OK]** button.

Message

You can manage voice messages by connecting to the Voicemail Box. You can also send and receive text messages and save a created message temporarily.

Voice Message

You can save or check a voice message.

Select **[Menu] → [Message] → [Voice Message]**, then you can go to the Voicemail Box. Check voice messages by following instructions.



Some functions are not supported depending on system

Creating a Message

This is the function used to create and save a message to send.

- 1 Press the **[Menu] → [Message] → [Short Message] → [New Nsg.]** soft button.



- 2 After creating a message, specify a recipient by pressing the **[OK]** button at the right.
 - **[Save]:** By pressing the below soft button, you can save a created message into the temporary box.



- 3 After entering a called number, press the **[Send]** soft button. Then the message is transmitted.
 - **[Search]:** You can search a phone number in the contacts.
 - A message can be sent up to 10 people at a time.



Received Messages

You can save and check a received message.

- 1 Select **[Menu]** → **[Message]** → **[Short Message]** → **[Inbox]**.



```
1 Inbox [0/0]
2 Outbox [0]
3 Draft Message [0]
4 Settings
New Msg
```

- 2 The list of received messages is displayed.
- **[Delete]**: You can delete a selected message.
 - **[Delete All]**: You can delete all the messages.

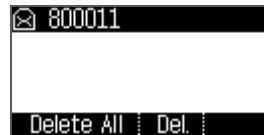

```
800011
Delete All Del
```

- 3 To view all message information, select the message and then press **[OK]** button.
- **[Reply]**: You can reply to a counterpart who sent a message.
 - **[Fwd]**: You can forward a message to others by pressing the below soft button.
 - **[Option]**: You can use following function.
 - **[Call]**: You can call the person who send the message.
 - **[Save]**: You can save the number who send the message.
 - **[Del]**: You can delete a message.

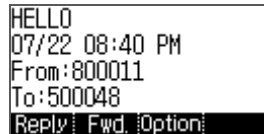

```
HELLO
07/22 08:40 PM
From: 800011
To: 500048
Reply Fwd Option
```

Sent Messages

You can save and check a sent message.

- 1 Select **[Menu]** → **[Message]** → **[Short Message]** → **[Outbox]**.

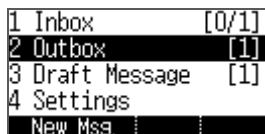

A screenshot of a mobile phone menu showing the following options: 1 Inbox [0/1], 2 Outbox [1], 3 Draft Message [1], 4 Settings, and New Msg. The 'Outbox' option is highlighted with a black background.

- 2 Lists of sent messages are displayed.
- **[Delete]**: You can delete a selected message.
 - **[Delete All]**: You can delete all the messages.



A screenshot of a mobile phone menu showing the number 500046 at the top right, a close button (X), and the options Delete All and Del. at the bottom.

- 3 To view all message information, select the message and then press **[OK]** button.
- **[Reply]**: You can reply to a counterpart who sent a message.
 - **[Fwd]**: You can forward a message to others by pressing the below soft button.
 - **[Option]**: You can use following function.
 - **[Call]**: You can call the person who send the message.
 - **[Save]**: You can save the number who send the message.
 - **[Del]**: You can delete a message.

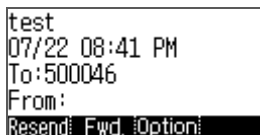

A screenshot of a mobile phone message details screen showing the following information: test, 07/22 08:41 PM, To: 500046, From:, and Resend: Fwd: Option: at the bottom.

Storage Box

This is the function used to save a created message temporarily.

- 1 Select **[Menu]** → **[Message]** → **[Short Message]** → **[Draft Message]**.



- 2 A temporarily saved message is displayed.
- **[Delete]**: You can delete a selected message.
 - **[Delete All]**: You can delete all the messages.



- 3 To view all message information, select the message and then press **[OK]** button.
- **[Forward]**: You can forward a message to others by pressing the below soft button.
 - **[Delete]**: You can delete a message.



Settings

You can set received message display method.

Language

Select **[Menu]** → **[Language]**. You can set language.
After rebooting, phone operates with selected language.



Supported language is vary depending on phone version or system.

System Options

You can select call services,



Supported function is vary depending on phone version or system.

Call Transfer

1 Select **[Menu]** → **[System Options]** → **[Call Transfer]**.

2 Select Call Transfer type, and input subscriber number to transfer, and press **[save]** soft button.

Absent Message

Select **[Menu]** → **[System Options]** → **[Absent Message]**..

- Select [Message to send](#).

Call

Select **[Menu]** → **[System Options]** → **[Call]**.

- Setting options for call.
- You can set CID display type, dial mode, answer mode, AOM display, etc.

Phone Name

Select **[Menu]** → **[System Options]** → **[Phone Name]**.

- Setting a phone name to use.

Station On/off

Select **[Menu]** → **[System Options]** → **[Station On/off]**.

- You can set auto holding, conversation time display, subscriber service, etc.

Extension Login

1

[Select **[Menu]** → **[System Options]** → **[Extension Login]**].

2

In case of not using Extension Login, if you press [Set], phone registration will be cancelled, and displays ID/Password input window.

After input ID/password for Extension Login, press [Login] or [OK] key, then you can login.

- If you press [release] during using Extension Login, you can register original ID again.
-

AOM

- 1 Select **[Menu]** → **[system Options]** → **[AOM]**.
You can view or set program-key and AOM device.

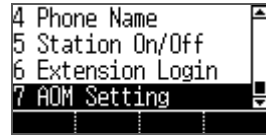

- 2 Move with arrow key or soft button, and push **[OK]** button, then detail information will be displayed. To change function, push **[Edit]** soft button.

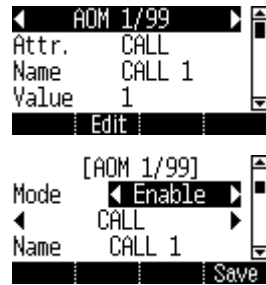

The AOM button setup function may not be available depending on system. If this function does not work properly, contact the system administrator. For detail information about how to use the AOM button function, refer to the SCM operation manual.

Settings

You can set up screen, sound, language, password and lock and retrieve the phone information.

Sound

Volume

Select **[Menu]** → **[Settings]** → **[Sound]** → **[Volume]**.

By pressing the navigation button, you can set the volume of a handset (receiver), speaker, ringtone, key tone, headset, message alert, and alarm respectively.

Ring Tone

Select **[Menu]** → **[Settings]** → **[Sound]** → **[Ring Tone]**.

You can set up a ringtone.

Key Tone

Select **[Menu]** → **[Settings]** → **[Sound]** → **[Key Tone]**.

You can set up a key tone.

Message Tone

Select **[Menu]** → **[Settings]** → **[Sound]** → **[Message Tone]**.

You can set up a message alert sound.

Bluetooth Ring

Select **[Menu]** → **[Settings]** → **[Sound]** → **[Bluetooth Ring]**.

You can set Bluetooth Ring Type.



Bluetooth Ring type is supported 6011 model only.

Screen

Date and Time

Select **[Menu]** → **[Settings]** → **[Screen]** → **[Date and Time]**.

Font

Select **[Menu]** → **[Settings]** → **[Screen]** → **[Font]**.

You can select font which is displayed on screen.

LCD Power Saving

Select **[Menu]** → **[Settings]** → **[Screen]** → **[LCD Power Saving]**.

Select the time when the LCD screen will be turned off.

- Always off/Off After 10 sec./Off After 20 sec./User configuration



Changing the default settings for the screen menu may affect the lifetime of the LCD and, therefore, do not change them if possible.
Below are shown the default LCD power Saving settings.

- Screen off: User Configuration (08:00 to 18:00)

Security

The user can set a password which is then used to set the functions of the phone, and the lock function. This prevents other people from using the phone.

- The default password is [1234].



If you forget password, contact to system manager.

Change Password

Select **[Menu]** → **[Settings]** → **[Security]** → **[Change Password]**.

You can change a password.

Menu Lock

Select **[Menu]** → **[Settings]** → **[Security]** → **[Phone]**.

Call Lock

Select **[Menu]** → **[Settings]** → **[Security]** → **[Call]**.

- **[Disable]**: you can disable Call Lock.
- **[Outbound]**: you can enable Outbound Call Lock.
- **[All]**: you can enable all Outgoing Call Lock.

Bluetooth & Headset

You can set up a function related to the headset and Bluetooth.



Bluetooth function is supported 6011 model only.

Using Hardware Headset Key

This prevents accidental presses Headset Key which is placed in front side.

- 1 Select **[Menu]** → **[Settings]** → **[Bluetooth & Headset]** → **[Headset Key]**.

- 2 You can select whether to use the headset button.
 - **[Enable]**: you can use a headset key by pressing the **[Headset]** button when a screen is waiting screen.
 - **[Disable]**: you can not use a headset key when a screen is waiting screen.



This function is not for using a Headset but for IP phone's Headset key.

Headset Mode

- 1 Select **[Menu]** → **[Setting]** → **[Bluetooth & Headset]** → **[Headset Mode]**.

- 2 You can adjust settings for the headset type to be used in the phone.
 - **[Standard]** You can use general voice call headset.
 - **[Bluetooth]** You can use Bluetooth headset.
 - **[EHS]** You can use EHS type headset.



If you set **[Bluetooth mode]** as Smartphone, you can use **[Headset mode]** as Standard only. And if you change setting, related setting value may be initialized.

Bluetooth Mode

SMT-i6011 Phone provides two kind of Bluetooth function.

- **[Headset]**: You can register and use Bluetooth headset to IP Phone.
- **[Smartphone]**: IP Phone works as Bluetooth Headset of smart phone.

In this case, to call with smart phone, you can use speaker or handset of IP phone.

- 1 Select **[Menu]** → **[Settings]** → **[Bluetooth & Headset]** → **[Bluetooth Mode]**.

- 2 Select Bluetooth mode.



- If you want to change **[Bluetooth mode]** as **[smartphone]**, you have to change **[Headset mode]** as **[Standard]** also.
- A Bluetooth headset is provided separately.
- The method of use and support may differ depending on the type of Bluetooth headset. Refer to the user manual of the Bluetooth device.
- EHS Equipment supported with phone is Plantronics APU-71.

Bluetooth Connection



[Bluetooth mode is 'Headset']

1 Select **[Menu]** → **[Settings]** → **[Bluetooth & Headset]** → **[Headset]** → **[Set]**.

2 After searching nearby Bluetooth devices, the connection information is displayed.



3 After selecting a Bluetooth headset to connect to the phone, press the **[Pair]** button. After checking it is the correct device, press the **[Yes]** button.
- The Bluetooth headset to connect must be in the pairing waiting mode.

4 If Bluetooth headset is connected, Bluetooth Icon () will be activated at the Title-Bar.
- If you use Bluetooth headset, you have to activate headset mode () by pressing headset key.
- The operation may differ from system.

5 When you press the **[Disconnect]** button, the device is disconnected. When you press the **[Remove]** button, the device is deleted from the search list as well as it is disconnected.

[Bluetooth mode is 'Smart Phone']

- 1 Select **[Menu]** → **[Settings]** → **[Bluetooth & Headset]** → **[Smartphone]** → **[Set]**.

- 2 To connect a smartphone to the phone, press **[Wait Pairing]** and start Bluetooth search in your smartphone.

[Smartphone conn.]

Waiting for
pairing...

- 3 When the smartphone is connected, you can use the call move function between the phone and smartphone.

- In the phone waiting screen, you can see 'Bluetooth' information is displayed under your phone number.
- When a call is received to the smartphone, there is a ringtone both at the phone and smartphone and you can select either one to receive the call.
- While talking through the smartphone, you can press the **[Headset]** button to move the call to the phone. You can also move a call from the phone to the smartphone by pressing the **[Move]** button.

[Headset conn.]

Do you want to
connect?
(3C:86:A8:00:03:69)

Yes No

- 4 When you press the **[Disconnect]** button, the device is disconnected.

- 5 When you press the **[Remove]** button, the device is deleted from the search list as well as it is disconnected.



Bluetooth is the name for a short-range radio networking technology that operates at 2.4 GHz to support wireless connection of various devices within a specific distance.

- Bluetooth may cause RF interference between low-power devices using the same frequency band such as the devices for industrial, scientific and medical use, microwave oven and wireless LAN units.
- Use Bluetooth devices at least 5 meters away from the wireless LAN area.
- Abnormal operation or noise may occur depending on the environment.

- If the user's obstructs signal transmission, abnormal operation or noise may occur.
- If a part of body contacts the radio transmission/receipt part of Bluetooth or a mobile phone, abnormal operation or noise may occur.
- Noise may occur depending on the position of the user if the reception power is reduced due to radio obstacles, e.g. walls and partitions.
- It may be difficult to talk due to the noise from the surroundings when the user is in a noisy area or outdoors.

User Data Initialization

Initialize all user setting and user data.

Setting Wi-Fi 5G Only

If you select Wi-Fi 5G Only mode, only 5G frequency is searched.

Select **[Menu]** → **[Settings]** → **[Wi-Fi 5G Only Set.]**



Wi-Fi 5G function is supported in 6011 model only.

Phone Information

Version Information

When you select **[Menu] → [Phone Information] → [Version Information]**, the phone model name or software version information is displayed.

- **[License]**: You can check the S/W license information.

Network information

When you select **[Menu] → [Phone Information] → [Network Information]**, the IP address, DSN information, or LAN connection status information, etc. is displayed.

Deskphone Manager Connection Information

When you select **[Menu] → [Phone Information] → [SDM Information]**, you can check the connection information of a mobile device.

- Display SDM (Samsung Deskphone Manager) App. Connection information.

- **[Confirm]**: A mobile device is disconnected.

INTEROPERATION SERVICE

Smart Phone Interoperation (SDM)

The Samsung Desktop Manager (SDM) is a smartphone application that allows a user to use the contacts, call log, or program keys and also do various settings by interoperating with SMT-i5343. The SDM supports Samsung Galaxy S2, S3, Note1, Note2, and Galaxy Note2 10.1'.

System Configuration Diagram

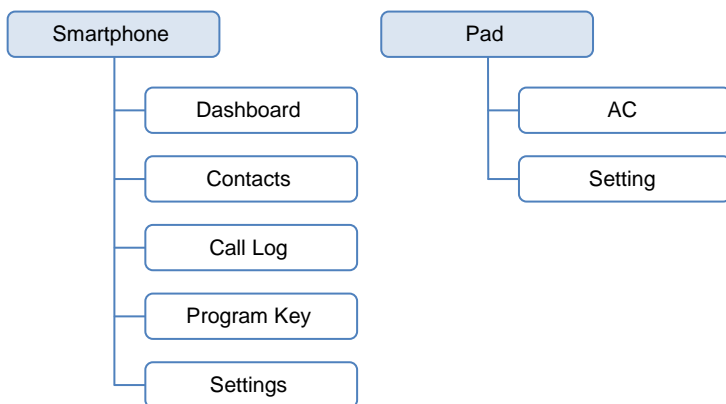

The SDM supports only the AOM function when it is installed on a pad. The authentication procedure is the same both in a smartphone and pad. Only layout is different.

Key Functions

Menu	Description
Dashboard	You can check or change the name or status (presence) of a currently connected user and also use contacts, call log, or AOM menu.
Contacts	You can manage the contacts of a smartphone, WeWork, and DeskPhone.
Call Log	You can manage the call log of a smartphone and deskphone.
Program Key (AOM)	You can use the program key and AOM function of deskphone.
Settings	You can set up the details of SDM.

Registration Methods

SDM uses WIFI and USB to interoperate with the IP phone. After SDM installation, you can connect to the IP phone in the following procedures. To use SDM, you have to register your IP phone. You need only one registration and authentication for first use, and after then it is registered automatically. But if network configuration or phone configuration is changed, then it may be needed re-registration.



To download and install SDM, contact system manager.

Registration Using WIFI

Authentication User ID

◆ Auto Login

Try a authentication with wireless network. In case of auto login, it automatically acquire and authenticate IP phone's network IP address, so you don't know IP phone's network information.



For Auto Login

- SDM user should know a account for IP phone connection.
- Wireless Network have to support multicasting data.

If you have trouble to auto login, contact system manager.

1 Start the app and press the Start button.



2 Enter an ID/PW and select 'Deskphone IP input'.

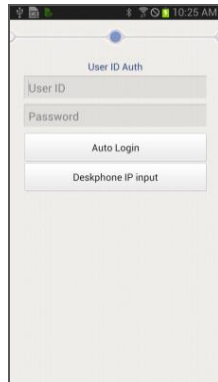

3 Enter deskphone IP information, and enter OK button.

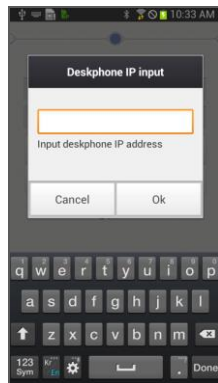

- 4 If authentication success, Dashboard screen will displayed.



- 5 If account information or IP phone address is incorrect, registration will be fail.
Contact to system manager.

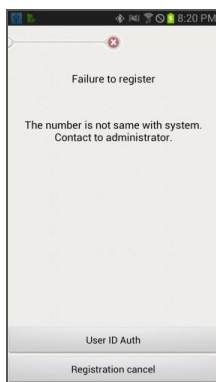

Registration Using USB

Smart phone uses USB tethering function with IP phone by USB data cable. In this case, IP phone and smart phone communicates 1:1 directly, so IP phone can't use smart phone's data communication and wireless network. This function is useful when used in environments without a wireless AP.



- For registration using USB tethering
- Smart phone can use USB tethering.
 - Smart phone don't need WiFi connection.

- 1 Activate Simple interlock mode of IP phones **[Menu]** → **[Setting]** → **[Deskphone Manager Information]**.

- Setting remains in effect until it is changed by the user.

- 2 Start the app and press the 'USB connection' button.

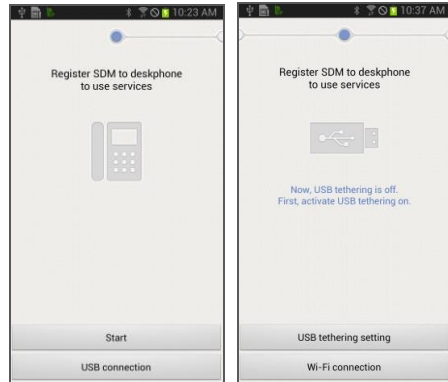

- 3 Turn on USB tethering by selecting USB tethering setting at the bottom and select the Back button.

If USB tethering is activated, then authentication is processed automatically.

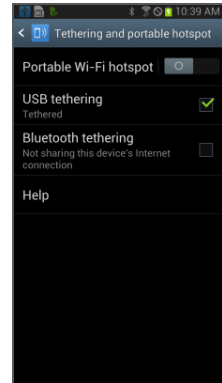

4

If the authentication procedure is successful, the dashboard screen is displayed.

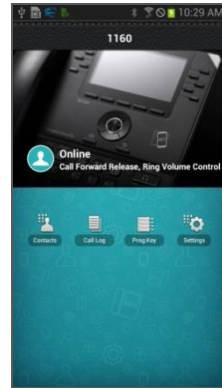

5

If phone number of smart phone address is not registered, you have to authenticate using account information.

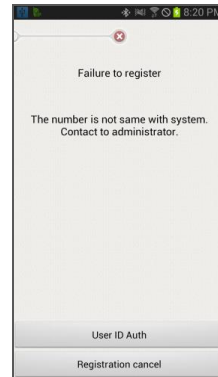

Deregistration

Disconnect the smart phone connected to the deskphone.

Deregistration in Settings

- 1 In the dashboard screen, go to 'Application settings' and select the 'Deregistration' in the 'Connection info setting'.

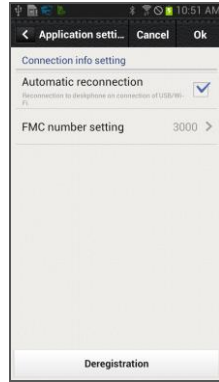

- 2 When the deregistration popup is displayed, press the 'Yes' button for deregistration.

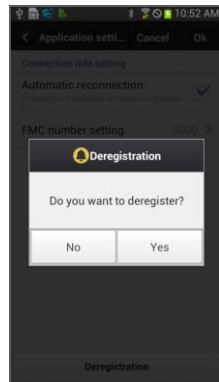

Dashboard

This is the first screen where you can change presence status or access key functions.

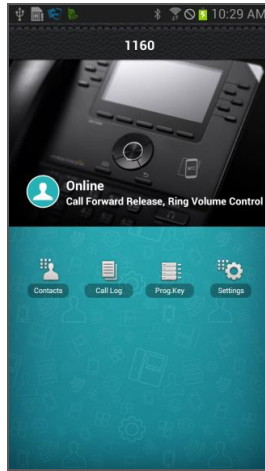

	Function	Description
Dashboard	Contacts icon	Moves to the contacts screen.
	Call Log icon	Move to the call log screen.
	Prog Key icon	Moves to the program key screen.
	Settings icon	Moves to the Settings screen.

Contacts

Contact List

You can manage the list of contacts (smartphone, deskphone, WeWork) per device. For copy or delete, it is changed to the selection mode.

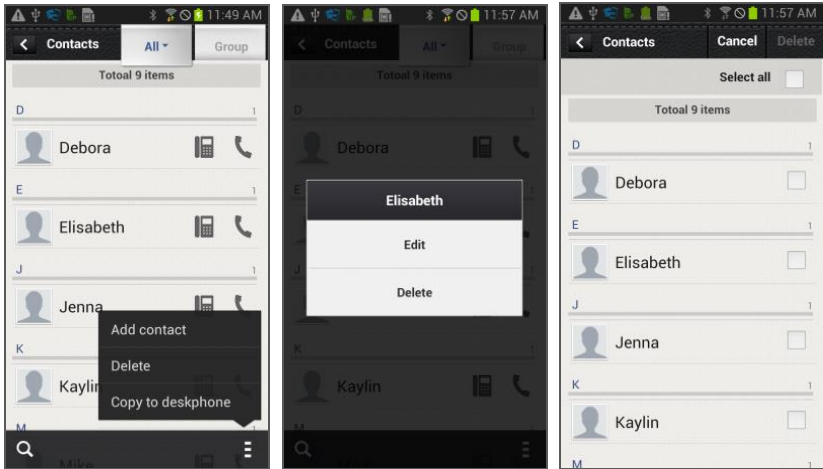

	Function	Description
Contact List	View contacts per device	You can see all the contacts of all, WeWork or deskphone.
	View group	You can see the group per device.
	View details	You can see the detail information of a selected contact.
	Search	You can search a contact.
	Add contact	You can add a contact.
	Delete	You can delete a contact.
	Copy to deskphone	You can save a contact to the deskphone.
	Dialing	You can make a call through the deskphone or smartphone.
	Long touch action	You can edit or delete a contact.



Contacts in smart phone can't be added/edited/deleted.

View contact details

You can check or manage the detail information of a contact.

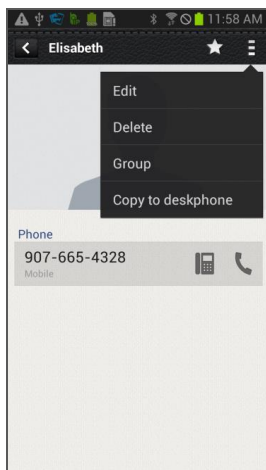

	Function	Description
View contact details	Favorites	You can enable/disable favorites.
	Dialing	You can make a call through the deskphone or smartphone.
	Edit	You can edit a contact.
	Delete	You can delete a contact.
	Group	You can manage the group of a contact.
	Copy to deskphone/Copy to smartphone	Copy a contact to the deskphone or smartphone.



Contacts in smart phone can't be added/edited/deleted.

Add/Edit contact

A popup asking where you want to add a contact is displayed when you add a contact. The fields may vary per device.

	Function	Description
Add/Edit Contacts	Enter name	You can enter it briefly or in detail.
	Add Group	Select a group by going to the group list screen.
	Select type	Select a type if it exists.

Select/Add group

When you press Add group in the Add/Edit Contacts screen, the below screen is displayed. You can select multiple groups for the contact or create a new group.

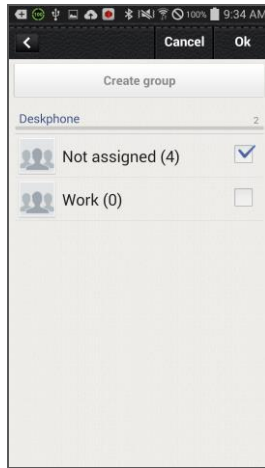

	Function	Description
Select Group	Create group	You can create a new group.
	Select Group	Select a group where a contact will belong.

Group List

You can see the list of groups per device. For deletion, it is changed to the selection mode.

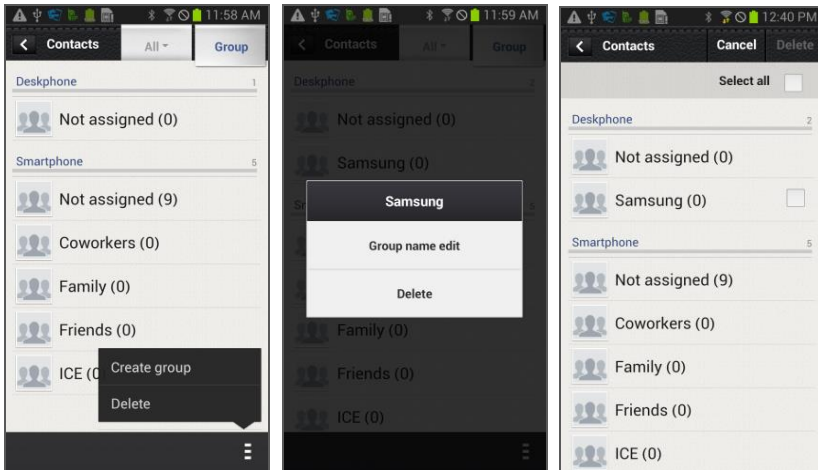

	Function	Description
Group List	View contacts	You can see the list of contacts.
	Create group	You can add a new group.
	Delete	You can delete a group.
	Long touch action	You can edit or delete a group name.



Contacts in smart phone can't be added/edited/deleted.

Group name edit

When you press group name edit after long touch in the group list, the below popup where you can enter a group name is displayed. Enter a name and press OK.

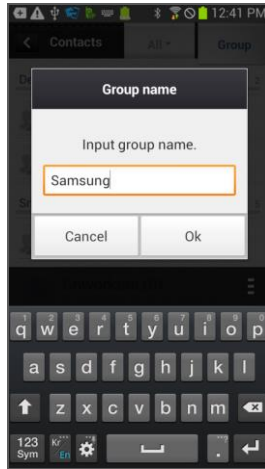

Add Group

After selecting a device, just as contacts, you can enter its name and select members.

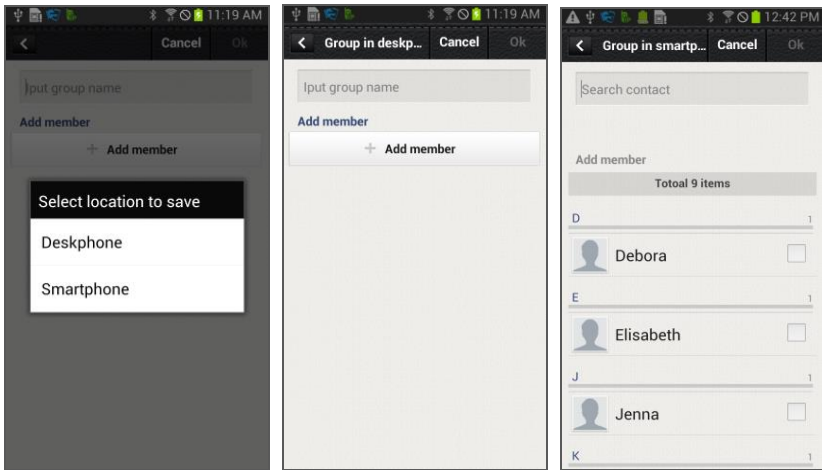

	Function	Description
Add Group	Enter name	Enter a group name. (If it is duplicate, there will be a warning popup.)
	Add Member	Moves to the member selection screen.
	Find Contact	You can search a contact using an entered keyword.

Contacts in Group

When you select a group, the contacts in the group are displayed. For deletion, it is changed to the selection mode. If you add a contact in a group, the device selection window is not displayed. (The contact automatically belongs to the group.)

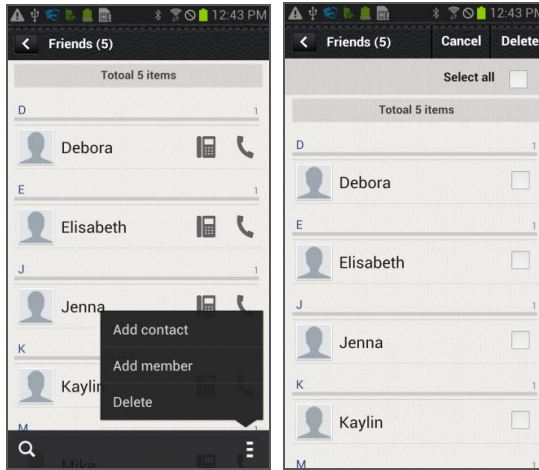

	Function	Description
Contacts in Group	Search	Search a contact in a group.
	Add contact	Create a contact in a group.
	Add Member	Manage a group member (add or remove).
	Delete	Delete a group member.

Add Member

You can add/remove a group member. The bar above means the selected contacts.

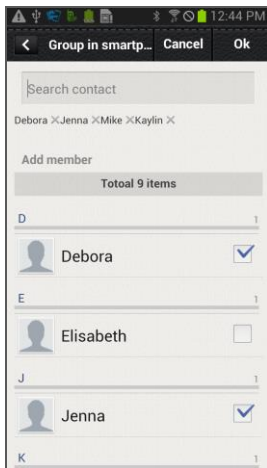

	Function	Description
Add Member	Select/Remove a group member	You can add a group member or remove an existing group member.
	Find Contact	You can search a contact using an entered keyword.

Search/Directory Search

You can search a contact by pressing the Search button (magnifier button). Basically, it is real time search and it supports initial sound search and phone number search. (The WeWork contacts do not support phone number search.) You can perform directory name search or number search by entering search keyword.

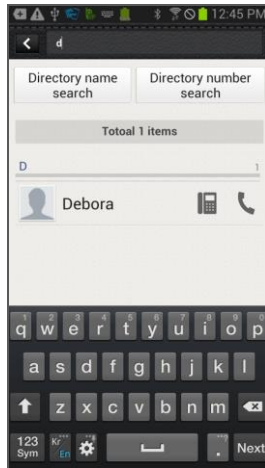

	Function	Description
Search/ Directory Search	Search	Real time search for a text entered in the search box
	Directory name search	Name based search in the directory service
	Directory number search	Number based search in the directory service

Call Log

Call Log

You can see the call log per device. You can classify calls per call log type and delete selectively or all the calls. The call log of deskphone is synchronized in real time.

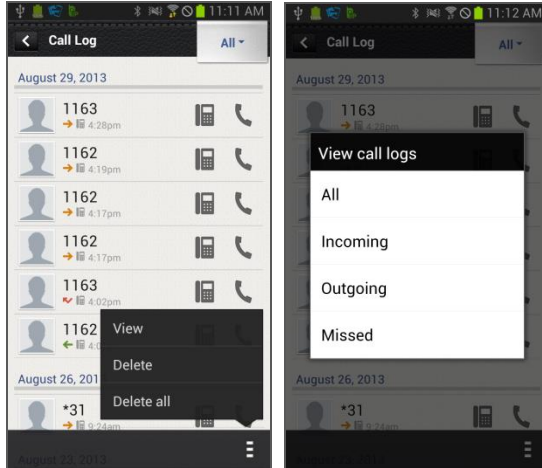

	Function	Description
Call Log	Call log per device	View call log per device (All, Deskphone).
	View	View by classifying per call log type. (All, Incoming, Outgoing, Missed)
	View call log details	View the detail information of a call log.
	Delete	Delete a call log.
	Delete all	Delete all the calls.



Contacts in smart phone can't be added/edited/deleted.

View call log details

View the detail information of a call log. Shows all the call log of a specific number in order and provides dialing and the contact interoperation function.



	Function	Description
View call log details	Dialing	You can make a call using the deskphone or smartphone.
	Delete	Delete a call log.
	Add/Edit	Add/Edit a new contact

Program Key

Only layout is different with a pad, but the functions are the same.

Program Key Main Screen

You can use program keys and the AOM function.

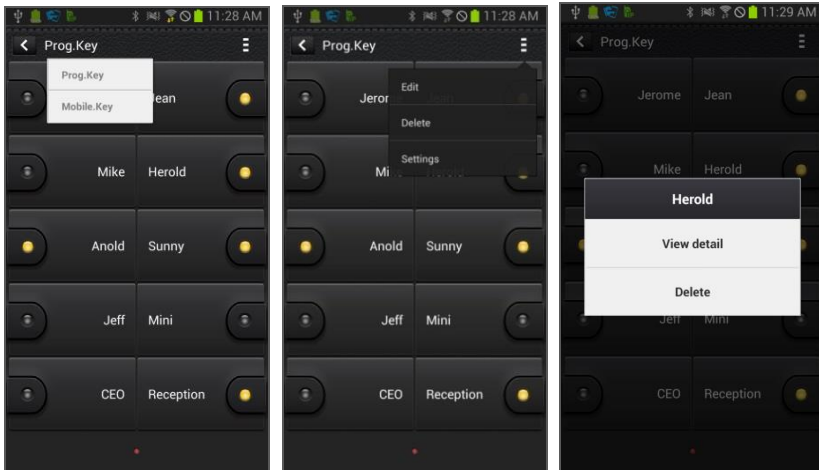

	Function	Description
Program Key	Change device	You can change a device by pressing its name.
	Change page	Using the left/right swipe at the top title bar, you can change a page.
	Add function	You can add a function.
	Long touch action	You can see the details and delete the information.
	Edit/Delete	You can edit or delete a function.
	Settings	Moves to the Settings screen.

Edit/Delete function

You can edit or delete a program key. It supports multi-tasking. You must press Save to make it applied after checking what you want to edit or delete.

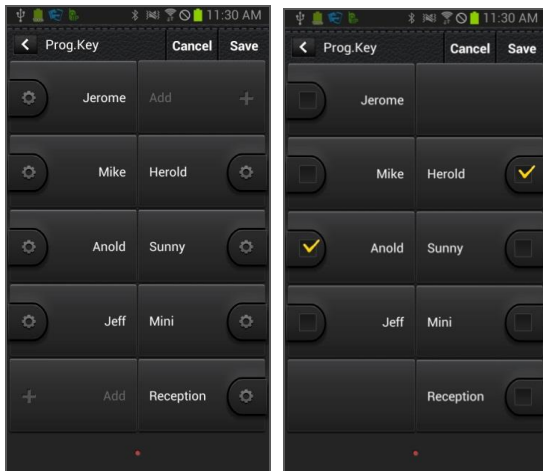

	Function	Description
Edit/Delete Function	Edit	Moves to the Edit screen.
	Delete	Select a function to delete.
	Done	Apply the changes.

Add/Edit Function screen

You can add or edit a function. Select a function and enter a value corresponding to the function.

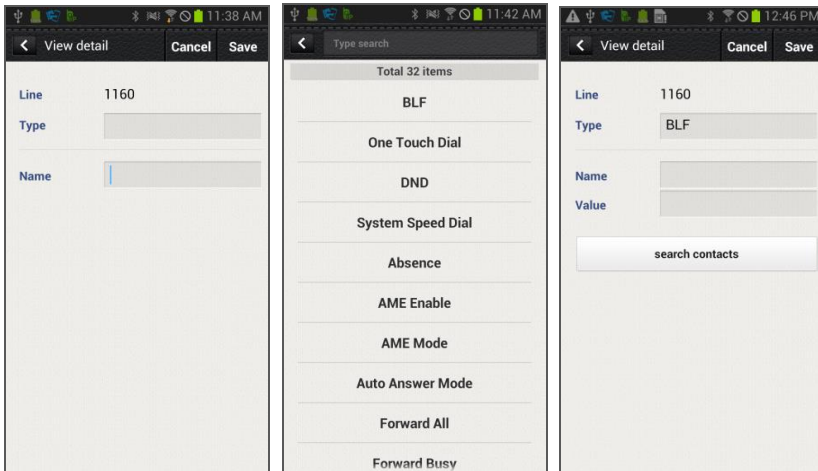

	Function	Description
Add/Edit Function screen	Select function	Move to the function selection screen and select a function you want.
	Input	Enter a value for the function or search the value.
	Done	Apply the addition or change.

Settings

Settings main screen

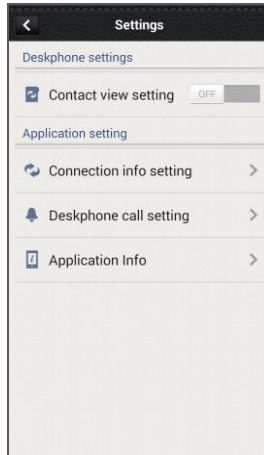

	Function	Description
Settings	Contacts view setting	Setting to view the contacts of a smartphone in IP phone.
	Connection info setting	Option setting for IP phone connection
	Deskphone call setting	Option setting for deskphone incoming call
	Application info	Check and upgrade application information.

Contacts Synchronization Setting

You can set up contacts view. If it is set to ON, you can see the contacts of smartphone in the deskphone. Contacts of smartphone does not saved in the deskphone.

Deskphone Connection setting

Setting for deskphone connection. You can check or uncheck auto re-connection, and manually register FMC number. If you have FMC number, it is registered automatically and can not modify. And SDM can be cancelled restration from Deskphone.

Deskphone incoming call notification

Setting for deskphone incoming call notification. Depending on the notification window check/uncheck, a notification bar is displayed when there is an incoming call. You can set up screen off status, sound, or vibration, etc. Based on this setting. This function may not supported depending your system.

SDM shortcut

If you select this when the SDM is registered to the deskphone, the SDM shortcut notification is registered to the notification bar.

Application info

Check the application information. You can do upgrade and NFC simple setting.

Smart CID

If you enabled Incoming call notification in Settings, the Smart CID is working whenever there is an incoming call to the deskphone. When you press the Close button (X), it is not displayed on the screen but it still remains in the notification bar. Therefore, you can load it anytime. You can accept or reject a call. When you accept a call, it is connected through the Samsung Mobile VoIP app.

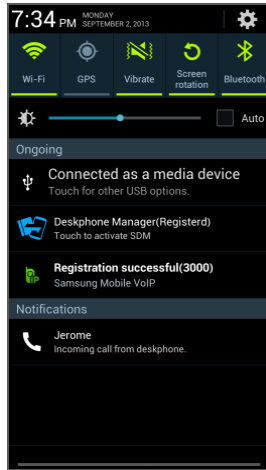

TROUBLESHOOTING

The following are examples of frequently occurring problems and solutions. Please check the list of solutions before requesting repair services from the service center. Please call the service center if the problem is not resolved using the following solutions.

Installation/Connection

Trouble	Solution
The phone is not reset after it is connected to the power supply.	<ul style="list-style-type: none">- Check if all of the cables are connected to the phone correctly.- Check if the power adapter meets the specifications. (Please use the optional power adapter provided. If you need to purchase a power adapter, please seek advice from the store where you purchased the phone.)- Disconnect the power adapter from the phone for about 10 seconds, and reconnect it.
The phone's functions do not work after the phone has been reset.	<ul style="list-style-type: none">- If the message 'IP conflict' appears on the screen, it means that your IP address is already being used (by a phone or PC). Please contact the system administrator.- If the message 'ID conflict' appears on the screen, it means that your ID is already being used by another phone. Please contact the system administrator.
When you pick up the phone or press the [Speaker] button, you cannot hear the dial tone.	<ul style="list-style-type: none">- Check if the power adapter and all of the cables are connected to the phone correctly.- Check if all of the network environments, such as the IP address, are set up correctly. (Please refer to 'Menu → Settings → 2. Network Information' in this user manual.)- Check if the IP address that has already been set up for the connected computer is available by using the 'ping' command. If the IP address is already being used, contact the system administrator to receive an available IP address.



Screen

Trouble	Solution
Nothing is displayed on the LCD screen during the call.	Check if the phone cables are properly connected to the ports. (Please refer to the section on 'Phone Installation' under 'Preparations' in this user manual.)



General

Trouble	Solution
The phone does not ring or the sound is too quiet.	By pressing the [Volume] button, make the phone bell volume larger. (Please refer to the 'Volume Control' section under 'Basic Functions' in this user manual.)
The sound is not clear due to interference or crossed lines.	If you were using the speaker, try using the handset.
There are a lot of echoes coming from the speaker.	When you broadcast, the noise from the speaker may cause echoing. Maintain a distance of 1 m from the phone.
Caller ID does not appear on the LCD screen.	<ul style="list-style-type: none"> - Ask the service provider whether the Caller ID service is activated. - If the user has requested to be removed from the Caller ID service, it will not appear on the screen. - If the user is calling from an area where the Caller ID service is not valid (e.g. making an international call), Caller ID will not appear on the screen. - If the user calls from a payphone, Caller ID will not appear on the screen. - If the user received invalid information from the service provider, Caller ID will not appear on the screen. - If the service provider does not provide the Caller ID service, Caller ID will not appear on the screen.
You are unable to access the main menu from the call forward or rejection screen.	Set the UC dial to a central position then you will be able to access the menu.

ANNEX

Product Specifications

The features and specifications of the SMT-i6010/6011 are as follows.

Item	Specifications
Model	SMT-i6010/6011
Weight (kg)	1,280 g \pm 5 % (Full Set; Unit Box included), Single Piece: 1,000 g \pm 5 %
Dimensions (mm)	240 (Width) \times 181 (Depth) \times 164 (Height)
LCD	Mono Graphic LCD (128 \times 64 Pixel)
Adaptor input power	AC 100-250 V/50-60 Hz, 1.0 A
Adaptor output power	DC 12 V; 2 A
PoE Input Power	DC 48 V; 0.3 A
PoE Device	802.3 af standard support (For CLASS 0)
Operating conditions	Temperature: 0-45°C, humidity: 10-90 %

Class B Device (Broadcasting communication device for home use)

This device obtained EMC registration mainly for home use (Class B) and may be used in all areas.

Caution: This wireless device is subject to electromagnetic interference.

Conformity Assessment and Product Safety Marks

■ SMT-i6010

Country	Certificate	Cert No.
EUROPE	CE	CB Certificate No. : NL-36551 CE
	CB	
USA/CANADA	FCC/IC	IC : 649E-SMTI6021 US : A3LIPNANSMTI6021
	UL	

■ SMT-i6011

Country	Certificate	Cert No.
EUROPE	CE	CB Certificate No. : NL-36551 NB No. : 1177 CE1177
	CB	
USA/CANADA	FCC/IC	IC : 649E-SMTI6021 US : A3LIPNANSMTI6021 FCC ID : A3LSMTI6021
	UL	

This image shows a blank sheet of handwriting practice paper. The page is enclosed in a rounded rectangular border. It features 20 horizontal rows, each consisting of a solid top line, a dashed midline, and a solid bottom line. The lines are evenly spaced and extend across the width of the page, providing a guide for letter height and placement.

This image shows a blank sheet of handwriting practice paper. The page is enclosed in a rounded rectangular border. It features 20 horizontal rows, each consisting of a solid top line, a dashed midline, and a solid bottom line. The lines are evenly spaced and extend across the width of the page, providing a guide for letter height and placement.

This image shows a blank sheet of lined paper designed for handwriting practice. The paper is enclosed in a light gray rounded rectangular border. It features 20 horizontal dashed lines spaced evenly down the page, providing a guide for letter height and placement. The lines are consistent in length and spacing, creating a clean and organized writing area.



WEEE SYMBOL INFORMATION



This marking on the product, accessories or literature indicates that the product and its electronic accessories (e.g. charger, headset, USB cable) should not be disposed of with other household waste at the end of their working life. To prevent possible harm to the environment or human health from uncontrolled waste disposal, please separate these items from other types of waste and recycle them responsibly to promote the sustainable reuse of material resources.

Household users should contact either the retailer where they purchased this product, or their local government office, for details of where and how they can take these items for environmentally safe recycling.

Business users should contact their supplier and check the terms and conditions of the purchase contract. This product and its electronic accessories should not be mixed with other commercial wastes for disposal.

CALIFORNIA USA ONLY

WARNING: This product contains chemicals known to the State of California to cause cancer, birth defects, or other reproductive harm.

Electronics Co., Ltd.

No information contained here may be copied, translated, transcribed or duplicated by any form without the prior written consent of SAMSUNG.

Information in this document is subject to change without notice.



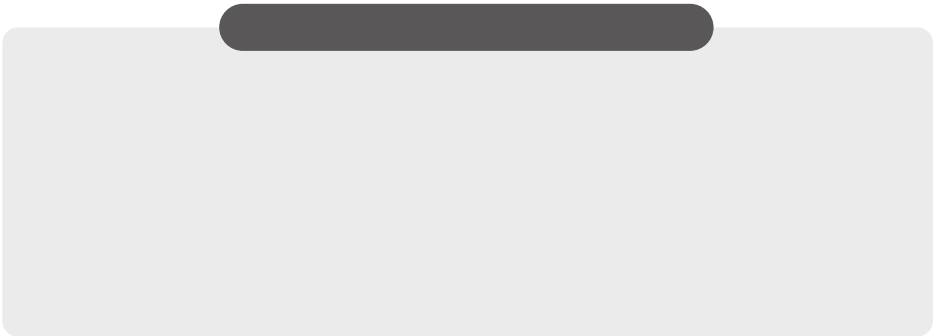

QUESTIONS OR COMMENTS?

[Homepage](#)

www.samsungnetwork.com



ELECTRONICS