

Yealink



HD IP Conference Phone CP960

Version 84.1
Jun. 2019

Copyright

Copyright © 2019 YEALINK(XIAMEN) NETWORK TECHNOLOGY

Copyright © 2019 Yealink (Xiamen) Network Technology CO., LTD. All rights reserved. No parts of this publication may be reproduced or transmitted in any form or by any means, electronic or mechanical, photocopying, recording, or otherwise, for any purpose, without the express written permission of Yealink (Xiamen) Network Technology CO., LTD. Under the law, reproducing includes translating into another language or format.

When this publication is made available on media, Yealink (Xiamen) Network Technology CO., LTD. gives its consent to downloading and printing copies of the content provided in this file only for private use but not for redistribution. No parts of this publication may be subject to alteration, modification or commercial use. Yealink (Xiamen) Network Technology CO., LTD. will not be liable for any damages arising from use of an illegally modified or altered publication.

Trademarks

Yealink®, the logo and the name and marks is trademark of Yealink (Xiamen) Network Technology CO., LTD, which are registered legally in China, the United States, EU (European Union) and other countries.

All other trademarks belong to their respective owners. Without Yealink's express written permission, recipient shall not reproduce or transmit any portion hereof in any form or by any means, with any purpose other than personal use.

Warranty

(1) **Warranty**

THE SPECIFICATIONS AND INFORMATION REGARDING THE PRODUCTS IN THIS GUIDE ARE SUBJECT TO CHANGE WITHOUT NOTICE. ALL STATEMENTS, INFORMATION, AND RECOMMENDATIONS IN THIS GUIDE ARE BELIEVED TO BE ACCURATE AND PRESENTED WITHOUT WARRANTY OF ANY KIND, EXPRESS OR IMPLIED. USERS MUST TAKE FULL RESPONSIBILITY FOR THEIR APPLICATION OF PRODUCTS.

(2) **Disclaimer**

YEALINK (XIAMEN) NETWORK TECHNOLOGY CO., LTD. MAKES NO WARRANTY OF ANY KIND WITH REGARD TO THIS GUIDE, INCLUDING, BUT NOT LIMITED TO, THE IMPLIED WARRANTIES OF MERCHANTABILITY AND FITNESS FOR A PARTICULAR PURPOSE. Yealink (Xiamen) Network Technology CO., LTD. shall not be liable for errors contained herein nor for incidental or consequential damages in connection with the furnishing, performance, or use of this guide.

(3) **Limitation of Liability**

Yealink and/or its respective suppliers are not responsible for the suitability of the information contained in this document for any reason. The information is provided "as is", and Yealink does not provide any warranty and is subject to change without notice. All risks other than risks caused by use of the information are borne by the recipient. In no event, even if Yealink has been suggested the occurrence of damages that are direct, consequential, incidental, special, punitive or whatsoever (Including but not limited to loss of business profit, business interruption or loss of business information), shall not be liable for these damages.

End User License Agreement

This End User License Agreement ("EULA") is a legal agreement between you and Yealink. By installing, copying or otherwise using the Products, you: (1) agree to be bounded by the terms of this EULA, (2) you are the owner or an authorized user of the device, and (3) you represent and warrant that you have the right, authority and capacity to enter into this agreement and to abide by all its terms and conditions, just as if you had signed it. The EULA for this product is available on the Yealink Support page for the product.

Patent Information

China, the United States, EU (European Union) and other countries are protecting one or more patents of accompanying products and/or patents being applied by Yealink.

Customer Feedback

We are striving to improve our documentation quality and we appreciate your feedback. Email your opinions and comments to DocsFeedback@yealink.com.

Technical Support

Visit Yealink WIKI (<http://support.yealink.com/>) for the latest firmware, guides, FAQ, Product documents, and more. For better service, we sincerely recommend you to use Yealink Ticketing system (<https://ticket.yealink.com>) to submit all your technical issues.

GNU GPL INFORMATION

Yealink phone firmware contains third-party software under the GNU General Public License (GPL). Yealink uses software under the specific terms of the GPL. Please refer to the GPL for the exact terms and conditions of the license.

The original GPL license, source code of components licensed under GPL and used in Yealink products can be downloaded online: http://www.yealink.com/onepage_83.html.

Table of Contents

Table of Contents	1
Before You Begin	8
Related Documentation	8
Getting Started	9
Hardware Overview	9
CP960 Hardware	9
Mute Touch Key LED Indicators	11
Screen and Icons	11
Control Center and Notification Center	11
Idle Screen	13
The Home Screen	13
The DSS Key Screen	14
Calls Screen	15
Icons in the Status Bar	15
CP960 Line Key Icons	16
Navigating Menus and Fields	17
Entering Information	17
Using the Onscreen Keyboard	18
English (UK) Input Method	18
Google Pinyin Input Method	20
Using the Dial Pad	21
Call Features	22
Placing Calls	22
Placing a Call from the Dialer	22
Placing Multiple Calls	23
Placing a Call with a Speed Dial Key	23
Placing a Call Back to the Last Incoming Number	23
Redialing a Number	24
Dialing a Hotline Number	24
Placing a Call from the Call History	24
Placing a Call from the Directory	24
Placing an Anonymous Call	25
Answering Calls	26
Answering a Call	26
Answering a Call When in a Call	26
Answering a Call Automatically	27
Disabling Call Waiting	27
Silencing or Rejecting Incoming Calls	28
Silencing a Call	28
Rejecting a Call Manually	28

Rejecting Anonymous Calls	28
Rejecting Calls with Do Not Disturb (DND)	28
Enabling DND	29
Disabling DND	29
Ending Calls	29
Redialing a Call Automatically	30
Call Muting and Unmuting	30
Keep Mute	31
Holding and Resuming Calls	31
Holding a Call	31
Resuming a Held Call	32
Redirecting Incoming Calls	32
Forwarding All Incoming Calls to a Contact	32
Forwarding an Incoming Call Manually	32
Forwarding Incoming Calls with a Forward Key	33
Diverting Calls to a Contact	33
Transferring Calls	33
Performing a Blind Transfer	34
Performing a Blind Transfer	34
Performing a Semi-Attended/Attended Transfer	34
Conference Calls	35
Local Conference	35
Initiating a Conference by Dialing Multiple Numbers	36
Initiating a Conference by Inviting Participants	36
Merging Multiple Calls into a Conference Call	37
Creating a Hybrid UC Conference	38
Holding/Resuming a Conference Call	39
Muting/Unmuting a Conference Call	39
Splitting a Conference Call	39
Managing the Conference Participants	39
Enabling/Disabling the DND Mode for a Conference Call	40
Managing the Conference Participants	40
Network Conference	40
Setting Up a Network Conference	40
Call Recording	41
Recording a Call	41
Recording a Conference	42
Setting a Mark When Recording a Call	42
Stopping a Recording	42
Checking Storage Space	42
Multicast Paging	43
Sending Multicast Paging	43
Setting a Multicast Paging Key	44
Sending a Paging by a Multicast Paging Key	44

Setting a Paging List Key	45
Setting a Paging Group	45
Sending Pages by a Paging List Key	46
Deleting a Paging Group	46
Receiving Multicast Paging	46
Managing a Paging Call	46
Advanced Call Features	48
Using Call Completion	48
Call Pickup	48
Picking up a Call Directly	49
Picking up a Group Call Directly	49
Picking up a Call with a Directed Pickup Key	50
Picking up a Call with a Group Pickup Key	50
Call Park	51
Configuring a Call Park Key	51
Using Call Park Feature	51
Busy Lamp Field (BLF)	52
State Indicator of Remote Line by BLF Key	52
Visual Alert for BLF Pickup	52
Setting a BLF Key	53
Picking up a Remote Call by BLF Key	53
Transferring a Call by BLF Key	54
Performing a Blind Transfer	54
Performing a Semi-attended/Attended Transfer	54
BLF List	54
State Indicator of Remote Line by BLF List Key	55
Visual Alert for BLF Pickup	55
Visual Alert for BLF Parked Call Monitor	55
Picking up a Remote Call by BLF List Key	56
Transferring a Call by BLF List Key	56
Performing a Blind Transfer	56
Performing a Semi-attended/Attended Transfer	57
Retrieving a Call by a BLF List Key	57
Barging in an Active Call by BLF List Key	57
Shared Line	57
State Indicator of Shared Line	58
Placing Calls on a Shared Line	58
Answering Calls on a Shared Line	58
Placing a Call on Public Hold	58
Placing a Call on Private Hold	59
Retrieving a Held Call on a Shared line	59
Barging in an Active Call on a Shared line	59
Pulling a Shared Call on a Shared line	60
Intercom	61

State Indicator of the Intercom key	61
Placing an Intercom Call	61
Picking up an Incoming Call of the Target Extension	61
Answering an Intercom Call	62
Voice Mail	63
Setting the Voice Mail Code	63
Leaving Voice Mails	63
Listening to Voice Mails	63
Using the Hot Desking	64
Directory	65
Local Directory	65
Managing the Local Directory Groups	65
Adding Contact Groups	65
Editing Contact Groups	65
Deleting Contact Groups	66
Managing the Local Directory Contacts	66
Adding Contacts	66
Viewing Contacts	66
Editing Contacts	66
Deleting a Contact	67
Deleting All Contacts	67
Moving a Local Directory Contact to Blacklist	67
Searching for Contacts	68
Blacklist	68
Adding a Blacklist Contact	68
Viewing Blacklist Contacts	69
Editing a Blacklist Contact	69
Deleting Blacklist Contacts	69
Deleting a Blacklist Contact	69
Deleting All Blacklist Contacts	69
Moving a Blacklist Contact to the Local Directory	70
Remote Phone Book	70
Searching for Remote Phone Book Contacts	70
Viewing Remote Phone Book Contacts	70
Saving a Remote Phone Book Contact to the Local Directory	71
Saving a Remote Phone Book Contact to the Blacklist	71
Call History	72
Call History Icons	72
Viewing History Records	72
Saving a History Record to Local Directory	72
Saving a History Record to Blacklist	72
Deleting History Records	73
Deleting a Call Record	73

Deleting All Call Records	73
Disabling History Record	73
System Applications	74
Recorder	74
Recording Audio	74
Playing a Recorded Call	75
Pause/Resuming a Playback	75
Fast Forwarding/Rewinding a Playback	75
Stopping a Playback	75
Copying Recorded Audio to USB Flash Drive	76
Copying All Recorded Audio to USB Flash Drive	76
Renaming the Recording	76
Deleting a Recording	76
Deleting All Recordings	77
Checking Storage Space	77
Browser	77
Browsing a Web Page	78
Managing Bookmarks	78
Adding a Web Page to the Bookmarks Library	78
Accessing a Web Page from the Bookmarks Library	79
Editing a Bookmark	80
Deleting a Bookmark	80
Setting a Home Page	80
Clearing the Navigation History	81
Modifying the Browser Settings	81
Clock	81
Customizing Your Phone	83
Changing the Administrator Password	83
Wallpaper	83
Changing Wallpaper on Idle Screen	83
Screen Saver	84
Changing the Waiting Time for Screen Saver	84
Setting the Screen Saver Type	84
Changing the Screen Backlight and Time	84
Changing the Language	86
Changing the Input Method	86
Time & Date	86
Setting the Time and Date Manually	87
Changing the Time and Date Format	87
Phone Lock	87
Setting the Phone Lock	87
Setting a Phone Lock Key	88
Locking Your Phone Manually	88

Unlocking Your Phone	88
Changing Your Phone Unlock PIN	88
Line Keys	89
Assigning Functionality to a Line Key	89
Changing the Locations of the Line Keys	90
Deleting a Line Key	90
Audio Settings	92
Adjusting the Volume	92
Setting the Ring Tone	92
Setting a Ring Tone for the Phone	92
Setting a Ring Tone for an Account	92
Setting a Ring Tone for a Group	93
Setting a Ring Tone for a Contact	93
Disabling the Key Tone	93
Enabling Touch Tone	93
Configuring Notification Sound	94
Enabling Silent Mode	94
Using Your Phone with PC	95
Connecting the PC to the Phone	95
Setting the Phone as PC Audio Device	96
Setting the Phone as PC Audio Device via Softphone	96
Setting the Phone as PC Audio Device via PC	97
Holding/Resuming the PC Audio	97
Muting or Unmuting the Microphone	97
Using the CP Wireless Expansion Mic CPW90	98
Placing the CPW90	98
Turning the CPW90 On or Off	98
Registering the CPW90	99
Registering the CPW90 with another Phone	100
Unregistering the CPW90	100
Muting or Unmuting the CPW90	100
Idle Mode	101
Viewing CPW90 Information	101
Finding the CPW90	101
Charging the CPW90	101
CPW90 LED Instructions	102
CPW90 Working Frequency	103
Using CP960 Star Connection Feature	105
State Indicator of CP960 Star Connection	105
Configuring the Master Phone	105
Setting Up a Star Connection Group	105
Sending Broadcast from Master Phone	106

Removing a Slave Phone	106
Dissolving a Star Connection Group	106
Finding a Slave Phone	106
Stop Finding a Slave Phone	107
Configuring the Slave Phone	107
Joining a Star Connection Group	107
Quitting a Star Connection Group	108
Finding a Master Phone	108
Stop Finding a Master Phone	108
Connecting a Mobile Phone Using Bluetooth	109
Activating the Bluetooth Mode	109
Pairing and Connecting the Bluetooth-enabled Mobile Phone	110
Configuring the Phone Audio Feature	111
Configuring the Media Audio Feature	111
Handling a Mobile Phone Call on the Phone	112
Renaming the Paired Bluetooth-enabled Mobile Phone	112
Disabling Bluetooth Device Discovery	112
Changing Your Phone's Bluetooth Name	113
Unpairing the Mobile Phone	113
Disconnecting the Bluetooth-enabled Mobile Phone	113
Deactivating the Bluetooth Mode	114
Wireless Network	115
Activating the Wi-Fi Mode	115
Connecting to the Wireless Network	115
Connecting to an Available Wireless Network Manually	115
Connecting to the Wireless Network Using Wi-Fi Protected Setup	116
Adding a Wireless Network Manually	116
Viewing the Wireless Network Information	117
Disconnect from a Wireless Network	117
Deactivating the Wi-Fi Mode	117
Maintaining Your Phone	119
Investigating Warnings	119
Clearing Warning Icon	119
Diagnosing the Network	120
Rebooting Your Phone	120
Resetting to Factory Settings	120
Updating the Phone Configuration	121
Clearing User's Personalized Configuration Settings	121
Appendix - Menu Structure	122

Before You Begin

This guide provides information you need to quickly use your new phone.

Firstly, verify with your system administrator that the IP network is ready for phone configuration. Also be sure to read the Quick Start Guide which can be found in your phone package before you set up and use the phone. As you read this guide, keep in mind that some features are only configurable by your system administrator or determined by your phone environment. As a result, some features may not be enabled or may be operated differently on your phone. Additionally, the examples and graphics in this guide may not directly reflect what is displayed or is available on your phone screen.

Related Documentation

You can view more types of documents to make the phone to perform more functions.

The following types of related documents are available on each support page on [Yealink support page](#):

- Release Notes, which details bug fixes and feature enhancements when an update is released.
- Quick Start Guide, which describes how to assemble your phone and configure the basic phone features.
- Administrator Guide, which provides the detailed information on how to configure phone features for system administrator.
- Regulatory Notice, which provides information about all regulatory and safety guidance.

You can also view other user documents which provide descriptions and examples for phone settings and features on [Yealink support page](#).

Getting Started

Before you use your phone, take some time to get familiar with its features and user interface.

Topics

[Hardware Overview](#)

[Screen and Icons](#)

[Navigating Menus and Fields](#)

[Entering Information](#)

Hardware Overview

Understanding the phone hardware helps you easily use the phone's features.

Topics

[CP960 Hardware](#)

[Mute Touch Key LED Indicators](#)

CP960 Hardware

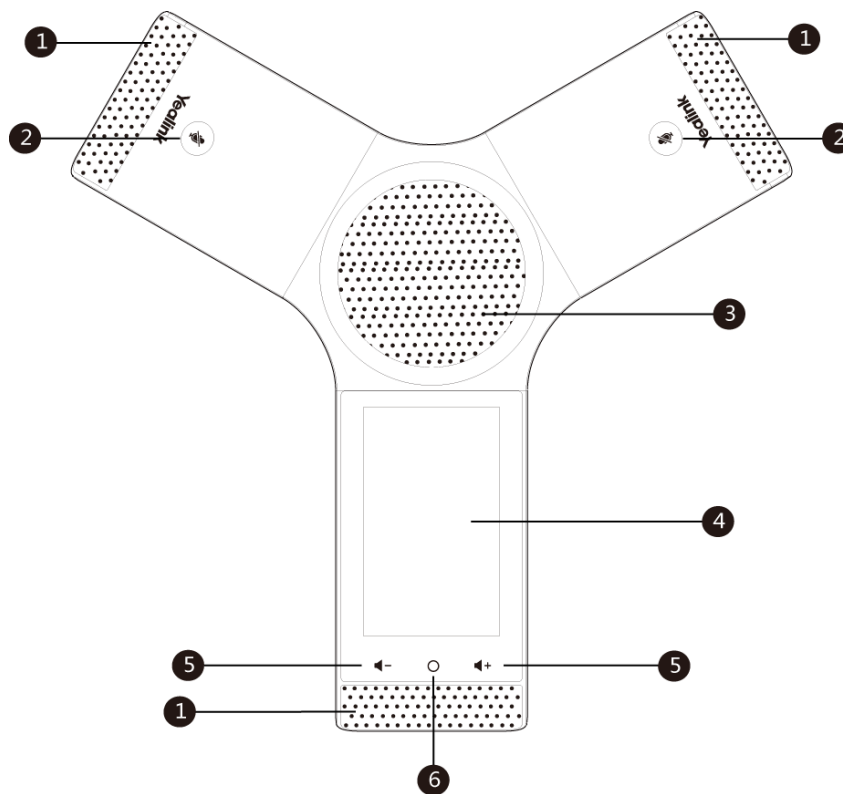

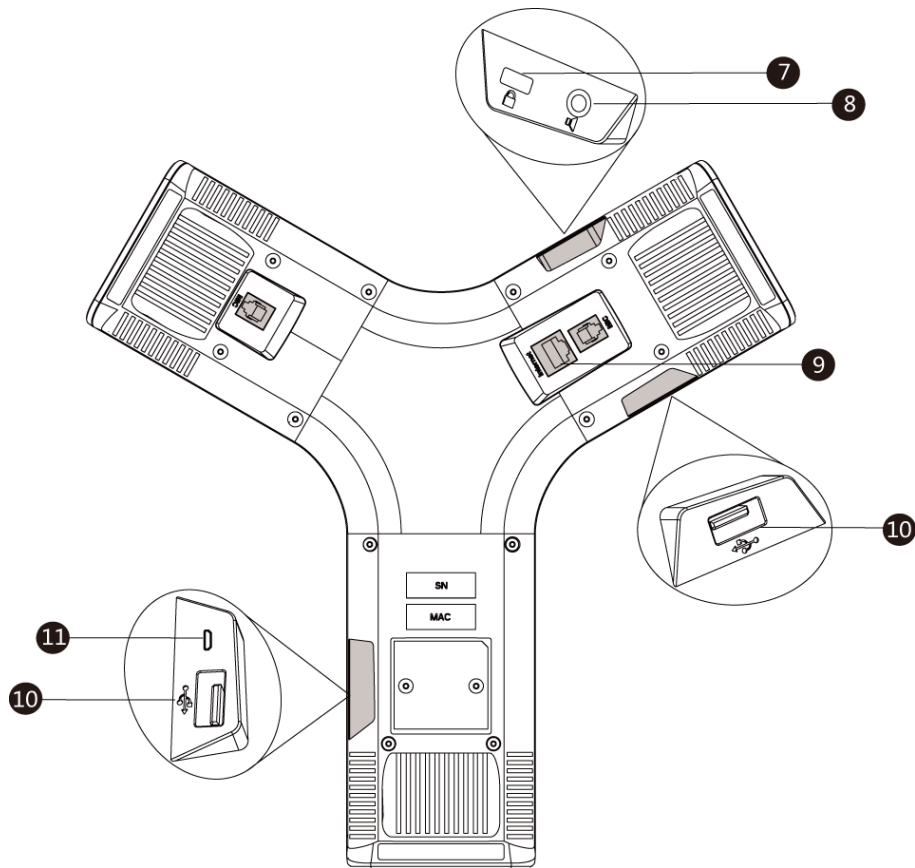

No.	Item	Description
1	Three Internal Microphones	Provide 20-feet and 360-degree coverage to transmit sound to other phones.
2	Mute Touch Keys	<ul style="list-style-type: none"> Indicate phone statuses. Toggle mute feature.
3	Speaker	Provides ringer and speakerphone audio output.
4	Touch Screen	Allows you to select items and navigate menus on the touch-sensitive screen. Tap to select items and navigate menus. Shows information about your phone, such as calls, messages, time and date.
5	Volume Touch Keys	Adjust the volume of the speaker, ringer or media.
6	HOME Touch Key	Returns to the idle screen.
7	Security Slot	Allows you to connect a universal security cable lock to your phone so you can secure it to a desktop.
8	3.5mm Audio-out Port	Allows you to connect an optional external speaker.
9	Network Port	Allows you to connect the phone to the wired network.
10	USB Ports	Allow you to connect an optional USB flash drive or CPW90 charging cradle.
11	Micro USB Port	Allows you to connect a PC and turn CP960 into an external speaker and microphone for your PC.

Mute Touch Key LED Indicators

The Mute touch key LED indicators indicate the call and phone status.

LED Status	Description
Solid red	The phone is initializing. The phone is muted.
Flashing red	The phone is ringing.
Solid green	The phone is placing a call. There is an active call on the phone.
Off	The phone is powered off. The phone is idle.

Screen and Icons

The user screens and icon indicators can help you navigate and understand the important information of the phone's status.

Topics

[Control Center and Notification Center](#)

[Idle Screen](#)

[Calls Screen](#)

[Icons in the Status Bar](#)

[CP960 Line Key Icons](#)

Control Center and Notification Center

Control center or notification center allows you to access common features or view important notifications quickly. You cannot enter the control center and notification center when calling, ringing or in a call.

Procedure

1. Swipe down from the top of the screen.

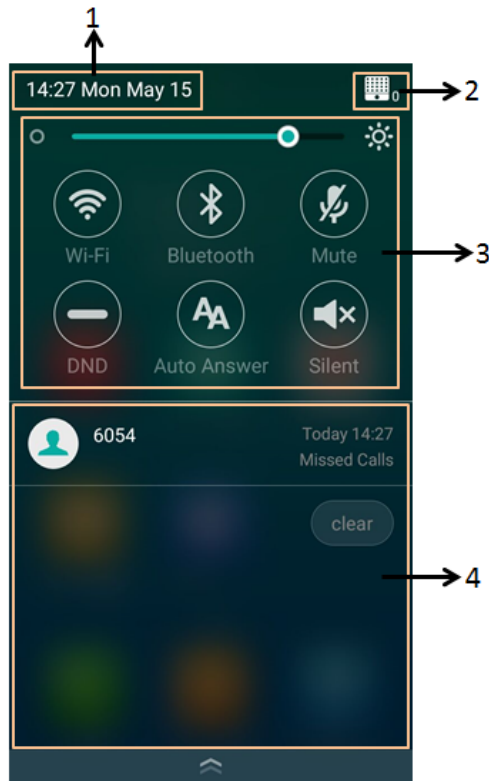

No.	Name	Description	
1	Time and date	Display the phone's time and date.	
2		<ul style="list-style-type: none"> Indicate the number of the connected wireless microphones. Tap to enter the wireless microphone settings screen. 	
3	Control Center	Backlight Slider	Drag the slider to adjust the screen brightness quickly.
		Wi-Fi	<ul style="list-style-type: none"> Tap to turn Wi-Fi on or off quickly. Long tap to enter Wi-Fi setting screen.
		Bluetooth	<ul style="list-style-type: none"> Tap to turn Bluetooth on or off quickly. Long tap to enter the Bluetooth setting screen.
		DND	Tap to turn DND on or off quickly.
		Auto Answer	Tap to turn auto answer on or off quickly.
		Mute	Tap to turn mute on or off quickly.
		Silent	Tap to turn silent mode on or off quickly.

No.	Name	Description
4	Notification Center	<ul style="list-style-type: none"> • Tap the desired notification message to view the details. • Swipe left or right to delete a specific notification. • Tap clear to delete all notifications.

Swipe up from the bottom of the screen or tap the Home touch key to exit this screen.

Idle Screen

Your phone supports two idle screens by default. You can swipe left or right to switch between two idle screens.

Note

A third idle screen will appear if your system administrator customizes shortcut keys for you.

Topics

[The Home Screen](#)

[The DSS Key Screen](#)

The Home Screen

The home screen mainly displays the registered account, time and date, and system applications.

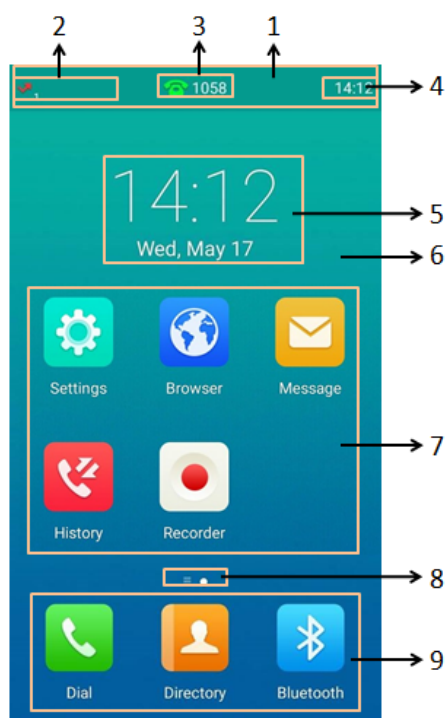

No.	Name	Description
1	Status Bar	Displays the label of the current account, icons and time.
2	Icons	Icons are displayed on the left of the status bar.
3	Current Account	<p>If there is no account registered on the phone, No Service appears.</p> <p>If the phone is registered and there is a Bluetooth-enabled mobile phone connected with the phone, Multiple account appears.</p>

No.	Name	Description	
4	Time	Displays the phone's time.	
5	Digital Clock Widget	Displays the phone's time and date.	
6	Wallpaper	Shows the specified wallpaper, which can be customized.	
7	System Applications	Settings	Tap to access phone settings and features.
		Browser	Tap to present and explore content on the World Wide Web.
		Message	Tap to access the voice mails or leave voice mails for someone.
		History	Tap to enter the History screen and view call history.
		Recorder	Tap to record audio.
8	Screen Indicator	Indicates idle screen you are currently viewing.	
9	Programmable Keys	Dial	Tap to enter the dialing screen.
		Directory	Tap to enter the Directory screen and view contacts.
		Bluetooth	Tap to enter the Bluetooth settings screen.

The DSS Key Screen

The DSS key screen displays phone's line keys.

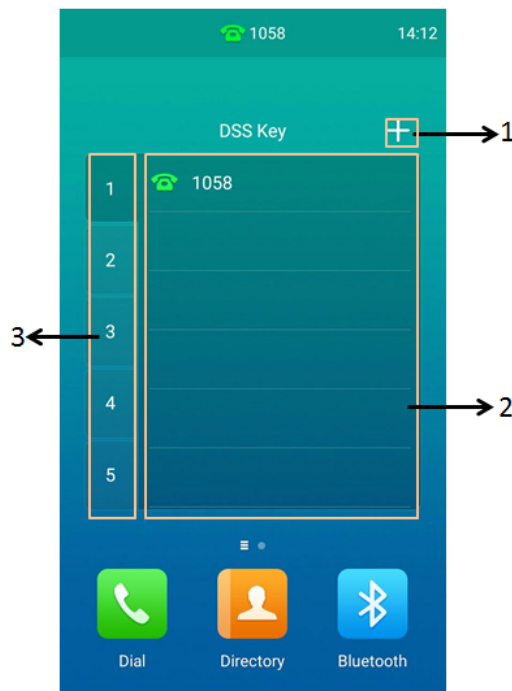

No.	Application	Description
1	+	Tap to add a line key.
2	Line Key List	Shows the line key labels. You can customize the line keys.
3	Page Keys	Tap to turn to the corresponding page.

Related Topic

Line Keys

Calls Screen

All of your active and held calls are displayed on the calls screen.

When there is an active call and a held call, the calls screen is shown as below:

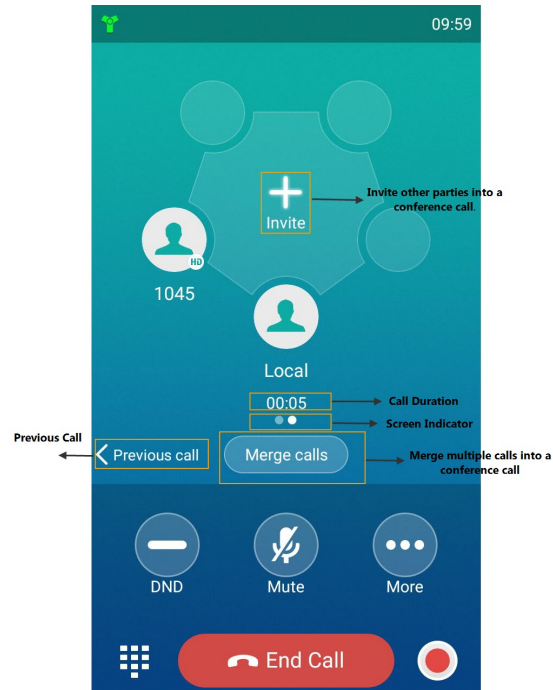

Icons in the Status Bar















The icons in the status bar help you easily get the current phone status, such as call and message status.

Icons	Description	Icons	Description
	Unavailable wired network		Missed Calls
	Voice Mail		Bluetooth enabled
	Auto Answer		Bluetooth-enabled mobile phone paired and connected
	Do Not Disturb		Wi-Fi enabled
	Call Forward		Wi-Fi signal strength from weak to strong after connecting successfully
	Silent mode		USB flash drive detected
	Keep Mute		Phone Warning
	Phone Lock		







CP960 Line Key Icons

By viewing the line key icons, you can easily get the function of the line key.



Icon indicator (associated with line key features):

Icons	Description	Icons	Description
	Hold		DND
	Voice Mail		Forward
	Direct Pickup		Group Pickup
	Speed Dial		ReCall
	Record		Recording in process (Record)
	Multicast Paging Paging List		Hot Desking
	Phone Lock		Directory





Icon indicator (associated with line)



Icons	Description	Icons	Description
	Registered private line		Register failed
 (Flashing)	Registering		Registered shared line
	DND is enabled on this line		Call forward is enabled on this line

Icon indicator (associated with the mobile account)

Icons	Description	Icons	Description
	Mobile Account (Bluetooth-enabled mobile phone is both paired and connected)		Mobile Account (Bluetooth-enabled mobile phone fails to connect)
 (Flashing)	Mobile Account (Bluetooth-enabled mobile phone is connecting)		

Icon indicator (associated with Intercom)

Icons	Description	Icons	Description
	Intercom idle state		Intercom ringing state
	Intercom callout state		Intercom talking state







Icons	Description	Icons	Description
Callout		Talking	
	Intercom failed state		Call forward is enabled on this line

Navigating Menus and Fields

You can use different gestures on the touch screen to perform various operations.

Procedure

1. To operate your phone using gestures, follow these tips:

Gesture		Action
Tap		Touch an item on the screen with your finger, and then lift your finger.
Long Tap		Touch an item for about 2 seconds without lifting your finger from the screen till an action occurs.
Swipe		Touch and move. When you want to scroll quickly, swipe your finger across the screen, either up, down, left or right.
Drag		Touch and hold, then move. To stop scrolling, stop the dragging motion.
Pinch Open		Touch the screen with two or more fingers, and then move the fingers away from each other (stretch).
Pinch Close		Touch the screen with two or more fingers, and then move the fingers towards each other (pinch).

Entering Information

The phone provides onscreen keyboard and dial pad to enter data. The dial pad provides a standard key layout, which enables you to use existing or familiar key positions.

Topics







[Using the Onscreen Keyboard](#)

[Using the Dial Pad](#)

Using the Onscreen Keyboard

The phone supports two kinds of input methods: English (UK) and Google Pinyin for the onscreen keyboard. You can enter information into text fields using the touch screen.

When you use the onscreen keyboard, the following things you need to know:

If you want to	Action
Position the cursor.	Tap to the position.
Select all characters.	<ol style="list-style-type: none"> 1. Long tap the entered character(s). 2. Do one of the following: <ul style="list-style-type: none"> • Tap  on the top of the phone screen. • Drag  to select all characters.
Cut/Copy characters.	<ol style="list-style-type: none"> 1. Long tap the entered character(s). 2. Drag  to select the characters you want to cut/copy. 3. Tap  on the top of the phone screen. 4. Long tap the desired field. 5. Tap PASTE.
Delete more characters at a time.	<ul style="list-style-type: none"> • Long tap the entered character(s). • Drag  to select the characters you want to delete. • Tap . • Long tap .
Replace characters.	<ol style="list-style-type: none"> 1. Drag your finger to highlight the characters you want to replace. 2. Tap the desired character.

Related Topic

[Changing the Input Method](#)

Topics



[English \(UK\) Input Method](#)

[Google Pinyin Input Method](#)

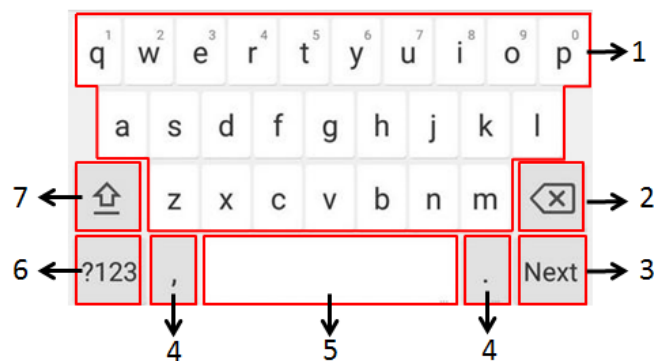
English (UK) Input Method



No.	Item	Description
1	26 English Letters	• Tap to enter letters.

No.	Item	Description	
		<ul style="list-style-type: none"> • Long tap a key then slide to choose one of the options to enter an alternate character. 	
2	Delete Key	<ul style="list-style-type: none"> • Tap to delete the entered characters one by one. • Long tap to delete two or more characters. 	
3	Label automatically to identify the context-sensitive features.	Next Key	Tap to go to the next field.
		Done Key	Tap to confirm the settings.
		Send Key	Tap to dial out the number.
		Go Key	Tap to browse the web page.
4	Two Special Characters	<ul style="list-style-type: none"> • Tap to enter special characters. • Long tap point key (.) then slide to choose one of the options to enter an alternate character. 	
5	Space Key	<ul style="list-style-type: none"> • Tap to enter spaces. • Long tap to change the input method. 	
6		Tap to switch to the numeric&symbolic input mode.	
7		Tap to switch to the uppercase input mode.	

Tap  to switch to the numeric&symbolic input mode as shown below:

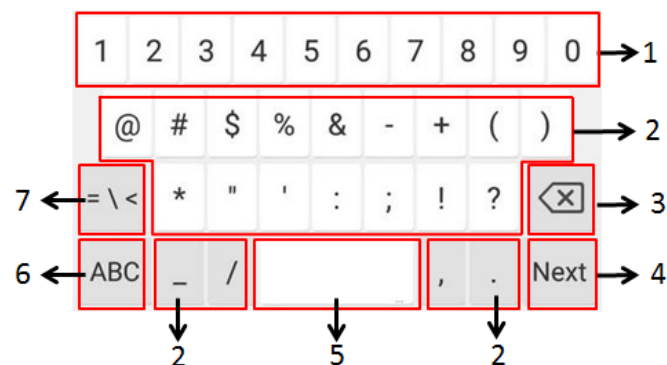

No.	Item	Description	
1	Numbers	<ul style="list-style-type: none"> • Tap to enter numbers. • Long tap a key then slide to choose one of the options to enter an alternate character. 	
2	Special Characters	<ul style="list-style-type: none"> • Tap to enter special characters. • Long tap a key then slide to choose one of the options to enter an alternate character. 	
3	Delete Key	<ul style="list-style-type: none"> • Tap to delete the entered characters one by one. • Long tap to delete two or more characters. 	
4	Label automatically to identify the context-sensitive features.	Next Key	Tap to go to the next field.
		Done	Tap to confirm the settings.

No.	Item	Description
	Key	
	Send Key	Tap to dial out the number.
	Go Key	Tap to browse the web page.
5	Space Key	<ul style="list-style-type: none"> Tap to enter spaces. Long tap to change the input method.
6	ABC	Tap to switch to the lowercase input mode.
7	= \ <	Tap to switch to the symbolic input mode.

Tap ~[< to switch to the symbolic input mode.

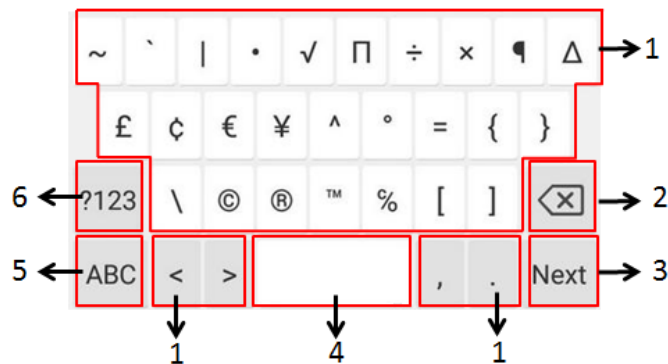

No.	Item	Description	
1	Special Characters	<ul style="list-style-type: none"> Tap to enter special characters. Long tap a key then slide to choose one of the options to enter an alternate character. 	
2	Delete Key	<ul style="list-style-type: none"> Tap to delete the entered characters one by one. Long tap to delete two or more characters. 	
3	Label automatically to identify the context-sensitive features.	Next Key	Tap to go to the next field.
		Done Key	Tap to confirm the settings.
		Send Key	Tap to dial out the number.
		Go Key	Tap to browse the web page.
4	Space Key	<ul style="list-style-type: none"> Tap to enter spaces. Long tap to change the input method. 	
5	ABC	Tap to switch to the lowercase input mode.	
6	?123	Tap to switch to the numeric&symbolic input mode.	

Google Pinyin Input Method

You can use Google Pinyin input method (谷歌拼音输入法) to enter Chinese characters.

When you change the input method to Google Pinyin, the onscreen keyboard displays the English input mode as shown below by default:

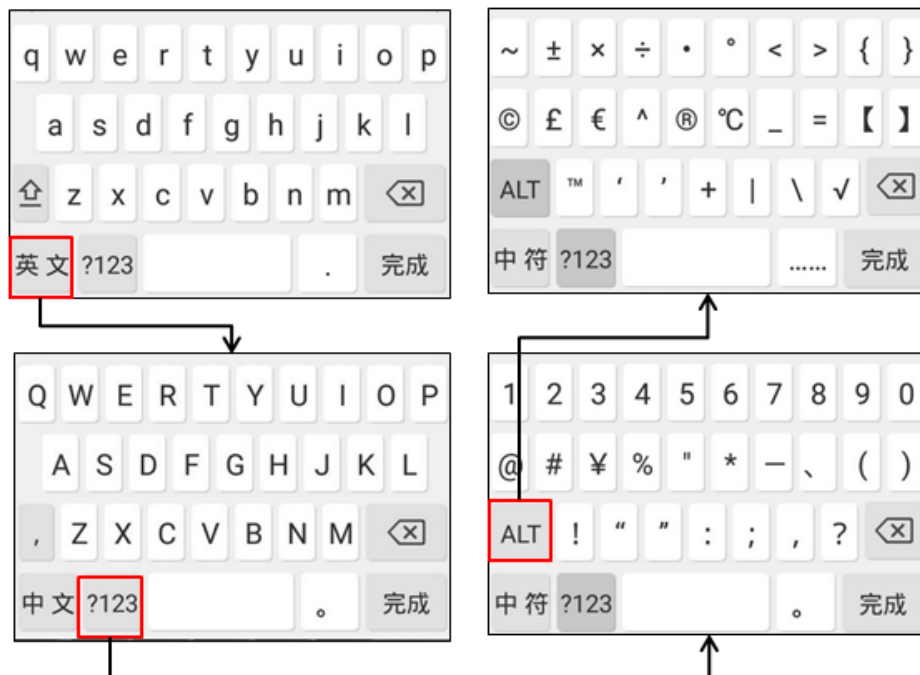

Using the Dial Pad

You can use the dial pad to enter data. The dial pad only provides digit keys, # key and * key.

You can tap  to switch to the onscreen keyboard.

Related Topic

[Using the Onscreen Keyboard](#)

Call Features

You can use the phone to place and answer calls, ignore incoming calls, transfer a call to someone else, conduct a conference call and perform other basic call features.

Topics

- [Placing Calls](#)
- [Answering Calls](#)
- [Disabling Call Waiting](#)
- [Silencing or Rejecting Incoming Calls](#)
- [Ending Calls](#)
- [Redialing a Call Automatically](#)
- [Call Muting and Unmuting](#)
- [Keep Mute](#)
- [Holding and Resuming Calls](#)
- [Redirecting Incoming Calls](#)
- [Transferring Calls](#)
- [Conference Calls](#)
- [Call Recording](#)
- [Multicast Paging](#)

Placing Calls

You can use your phone like a regular phone to place calls in many ways easily.

Topics

- [Placing a Call from the Dialer](#)
- [Placing Multiple Calls](#)
- [Placing a Call with a Speed Dial Key](#)
- [Placing a Call Back to the Last Incoming Number](#)
- [Redialing a Number](#)
- [Dialing a Hotline Number](#)
- [Placing a Call from the Call History](#)
- [Placing a Call from the Directory](#)
- [Placing an Anonymous Call](#)

Placing a Call from the Dialer

The Dialer enables you to enter a number to place a call, and it displays a list of previously placed calls or contacts in your directory.

You can also select the desired contact from the search list, the placed call list or Directory.

Note

Your system administrator can configure the source list for searching and disable to display the placed call records.

Procedure

1. Tap .
2. Enter a number.
3. Select **Send**.

Note

Your system administrator can enable live dialpad feature, which enables your phone to automatically dial out the phone number after a period of time without selecting **Send**.

Placing Multiple Calls

When you are in a call, you can hold your current call and place a new call.



Procedure

1. Tap **More > New Call**.
2. Enter the desired number or select a contact.
3. Select **Send**.

Placing a Call with a Speed Dial Key

You can quickly dial a number by using a Speed Dial key.

Procedure

1. Navigate to **Settings > Features > Dsskey**.
2. Select the desired line key.
3. Select **SpeedDial** from the **Type** field.
4. Select the desired line from the **Account ID** field.
5. Do one of the following:
 - (Optional.) Enter the string that will appear on the phone screen in the **Label** field.
Enter the contact number you want to dial out directly in the **Value** field.
You can also enter the contact number with the DTMF sequence that you want to send in the **Value** field. The contact number and DTMF sequence are separated by commas. One comma stands for 500 milliseconds. For example, **1234,,123#** means the phone dials out the number 1234 first, then after the call is set up for 1 second, it sends the DTMF sequence 123# to the remote party.
 - Tap , and then tap the desired contact.
6. Tap .

Tips

By default, you can drag the line key to the **Edit** field to set it.

When the phone is idle, you can tap the Speed Dial key to call a contact quickly. The phone calls a contact using the configured line by default. If you want to call a contact using another line, you can first tap the line key, and then tap the Speed Dial key.

Placing a Call Back to the Last Incoming Number

You can redial the last incoming number quickly by using a Recall key.

Procedure

1. Navigate to **Settings > Features > Dsskey**.
2. Select the desired line key.
3. Select **Key Event** from the **Type** field.
4. Select **Recall** from the **Key Type** field.

5. (Optional.) Enter the string that will appear on the phone screen in the **Label** field.
6. Tap .

Tips

By default, you can drag the line key to the **Edit** field to set it.

When the phone is idle, tap the Recall key to quickly redial the last incoming number.

Redialing a Number

The phone keeps a record of all the placed calls. You can recall the contact you recently called.



Procedure

1. Tap  .
The phone screen displays the placed calls list.
2. Tap the desired record.

Dialing a Hotline Number

When the phone is off-hook, it will dial out the hotline number automatically after the designated delay time.

Procedure

1. Navigate to **Settings > Features > Hot Line**.
2. Do one of the following:
 - Enter the desired number in the **Number** field.
 - Tap , and then tap the desired contact.
3. Enter the desired delay time (0-10 seconds) in the **Hotline Delay** field.
4. Tap .

Placing a Call from the Call History

You can place calls to contacts from the History list, which contains the calls that were recently placed, answered, missed, or forwarded.

Procedure

1. Tap  or navigate to **Menu > History**.
The phone screen displays all call records.
2. Tap **Local Calls** and select the desired history list.
3. Tap the desired entry.

Placing a Call from the Directory

You can place a call to a contact directly from your directory.

Procedure

1. Tap .
2. Select the desired directory.
3. If the contact was added to a specified contact group, you can tap **Local Directory** to select the desired contact

group.

4. Tap the desired contact.

If the selected contact has multiple numbers, tap the desired number to dial out.

Related Topic

[Searching for Contacts](#)

Placing an Anonymous Call

You can hide your name and number when you place a call. As a result, the callee receives an anonymous call without caller identity.

Before You Begin

Contact with your system administrator to find out if this feature is available on your phone, and to get the anonymous call on code or off code if required.

Procedure

1. Navigate to **Settings > Features > Anonymous**.
2. Select the desired line.
3. Turn on **Local Anonymous**.
4. (Optional.) Turn on **Send Anony Code**.
5. (Optional.) Enter the anonymous call on code and off code respectively.
6. Tap  .
7. Place a call.

The callee is prompted with an incoming call from anonymity.

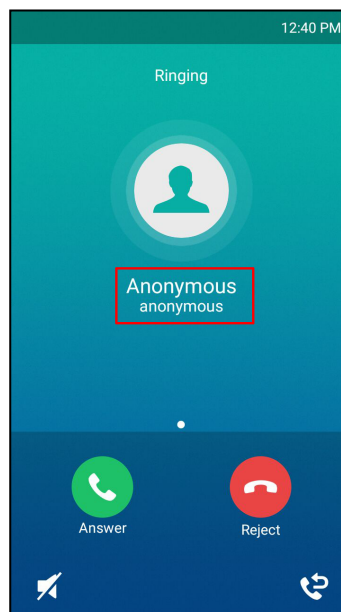

If the callee enables anonymous rejection feature, you may be prompted that the callee does not accept calls from an anonymous number.

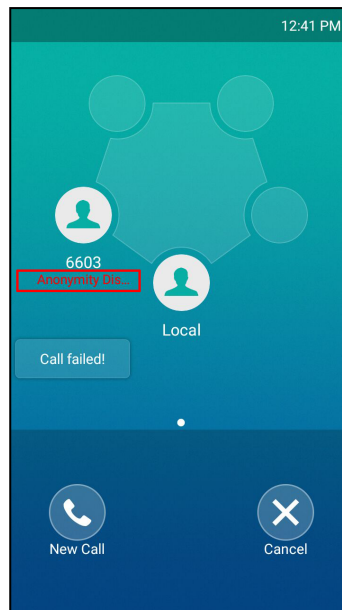

Related Topic

[Rejecting Anonymous Calls](#)

Answering Calls

When you receive a call, you can choose to answer it manually or automatically.

Topics

[Answering a Call](#)

[Answering a Call When in a Call](#)

[Answering a Call Automatically](#)

Answering a Call

When you receive an incoming call, the phone rings and the screen displays the information of the incoming call. You can choose to answer the incoming call.

Procedure

1. Tap **Answer**.

Answering a Call When in a Call

You can answer a call when there is already an active call on your phone.

When you are in an active call and an incoming call arrives on the phone, a call waiting tone beeps, and the incoming call information is displayed.

Procedure

1. Select **Answer**.

The active call is placed on hold, and the incoming call becomes active.

Note

You can disable the call waiting feature to reject the incoming call automatically during a call.

Related Topic

[Disabling Call Waiting](#)

Answering a Call Automatically

Auto answer enables you to automatically answer an incoming call in speakerphone (hands-free) mode when your phone is idle.

You can also enable auto answer mute to mute the local microphone when an incoming call is answered automatically.

Procedure

1. Navigate to **Settings > Features > Auto Answer**.
2. Enable the **Auto Answer**.
3. Enable the **Auto Answer Mute**.
4. Tap  .

If the auto answer feature is enabled, the auto answer icon appears on the phone screen.

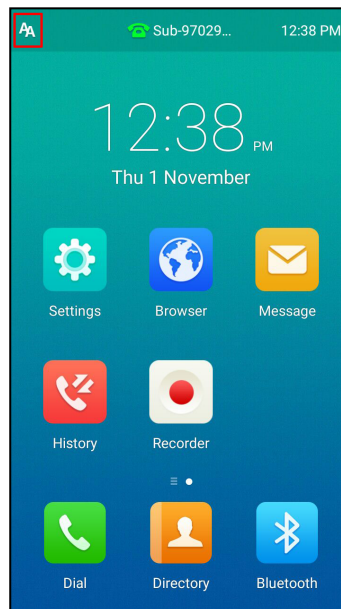

Disabling Call Waiting

If call waiting feature is disabled, when there is already a call, the new incoming call will be rejected automatically.

Before You Begin

Check with your system administrator if the call waiting off code is required. If required, get it from your system administrator.

Procedure

1. Navigate to **Settings > Features > Call Waiting**.
2. Turn off **Call Waiting**.
3. (Optional.) Enter the call waiting off code respectively in the **Off Code** field.
4. Tap  .

Silencing or Rejecting Incoming Calls

When you receive an incoming call, you can choose to silence or reject the call instead of answering.

Topics

[Silencing a Call](#)

[Rejecting a Call Manually](#)

[Rejecting Anonymous Calls](#)

[Rejecting Calls with Do Not Disturb \(DND\)](#)

Silencing a Call

You can silence a call to stop your phone from ringing. Even if you silence the call, the incoming call notification continues to be displayed on your phone.

Procedure

1. Select  .

Rejecting a Call Manually

You can reject a call manually, and the call may be sent to voice mail. The rejected calls are displayed in the Received Calls list in your History list.

Procedure

1. Tap **Reject**.

Rejecting Anonymous Calls

You can reject incoming calls from the callers who have hidden their identities. As a result, your phone will not ring and you will not be notified of an attempted call.

Before You Begin

Check with your system administrator if the anonymous call rejection on code or off code is required. If required, get it from your system administrator.

Procedure

1. Navigate to **Settings** > **Features** > **Anonymous**.
2. Select the desired line.
3. Turn on **Anonymous Rejection**.
4. (Optional.) Turn on **Send Rejection Code**.
5. Enter the anonymous call rejection on code and off code respectively in the **On Code** and **Off Code** field beneath the **Send Anonymous Rejection Code** field.
6. Tap  .

Related Topic

[Placing an Anonymous Call](#)

Rejecting Calls with Do Not Disturb (DND)

You can enable DND to reject all incoming calls automatically when you do not want to be interrupted.

If you want to receive incoming calls from the specific numbers when DND is enabled, you can ask your system administrator to set DND Authorized Numbers.

Note

Check with your system administrator to find out if the DND feature is available on your phone.

Topics

[Enabling DND](#)

[Disabling DND](#)

Enabling DND

You need to enable DND feature first if you want the phone to reject all incoming calls automatically.

Procedure

1. Do one of the following:
 - Swipe down from the top of the screen to enter the control center and toggle **DND** on.
 - Navigate to **Settings > Features > DND**.
Turn on **DND Status**.
Tap .
 - Tap **DND** during a call.

When DND is enabled, the phone prompts "DND mode is enabled" and the DND icon  appears on the status bar.

Incoming calls will be rejected automatically and "n New Missed Call(s)" ("n" indicates the number of missed calls. For example, 1 New Missed Call(s)) will appear on the phone screen.

Note

When DND and busy forward are enabled, all incoming calls will be forwarded to the configured destination number. For more information on busy forward, refer to [Forwarding All Incoming Calls to a Contact](#).

Disabling DND

You can deactivate DND when you are ready to resume receiving calls again.

Procedure

1. Do one of the following:
 - Tap **Exit DND mode** from the idle screen.
 - Swipe down from the top of the screen to enter the control center and toggle **DND** off.
 - Navigate to **Settings > Features > DND**, turn off **DND Status** and then tap .

Ending Calls

You can end the current call at any time.

Procedure

1. Tap **End Call**.

Redialing a Call Automatically

You can set the phone to redial a phone number automatically when you call a contact and the contact's line is unavailable.

Procedure

1. Navigate to **Settings > Features > Auto Redial**.
2. Turn on **Auto Redial**.
3. Enter the desired time (between 1 and 300 seconds) in the **Redial Interval** field.
4. Enter the desired times (between 1 and 300) in the **Redial Times** field.
5. Tap .

When you dial a number but fail to establish a call, the phone prompts whether to auto redial the contact, select **OK** to activate auto redial.

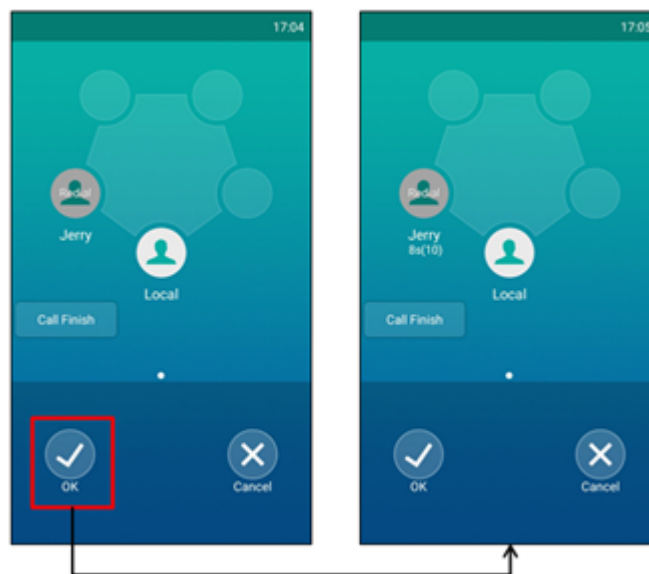

The phone screen displays the redial times and interval. The phone will retry as many times as configured until the callee answers the call.

Call Muting and Unmuting

You can mute the microphone during an active call so that the other party cannot hear you.

Procedure

1. During a call, tap the Mute touch key or **Mute**.
2. Tap the Mute touch key or Mute again to unmute the microphone.

Note

Contact your system administrator, if you can only mute the microphone during an active call or the mute feature is deactivated when the active call ends.

Keep Mute

In a meeting room, if incoming calls are answered automatically on your phone, callers may hear your discussion with your colleagues. You can keep the phone in mute to prevent this unintended situation.

The mute state of your phone persists across calls. The phone stays in the mute state until you unmute the microphone manually or until the phone restarts.

Procedure

1. Tap the Mute touch key when the phone is idle.
The mute key LED glows red, and the mute icon appears on the idle screen.
2. Tap the Mute touch key again to deactivate the mute state.

Holding and Resuming Calls

You can place an active call on hold and resume the call when you are ready. When you place a call on hold, the held party may hear the music played by its sever.

Topics

[Holding a Call](#)

[Resuming a Held Call](#)

Holding a Call

You can place an active call on hold on your phone.

Procedure

1. Tap **More** > **Hold** during a call.

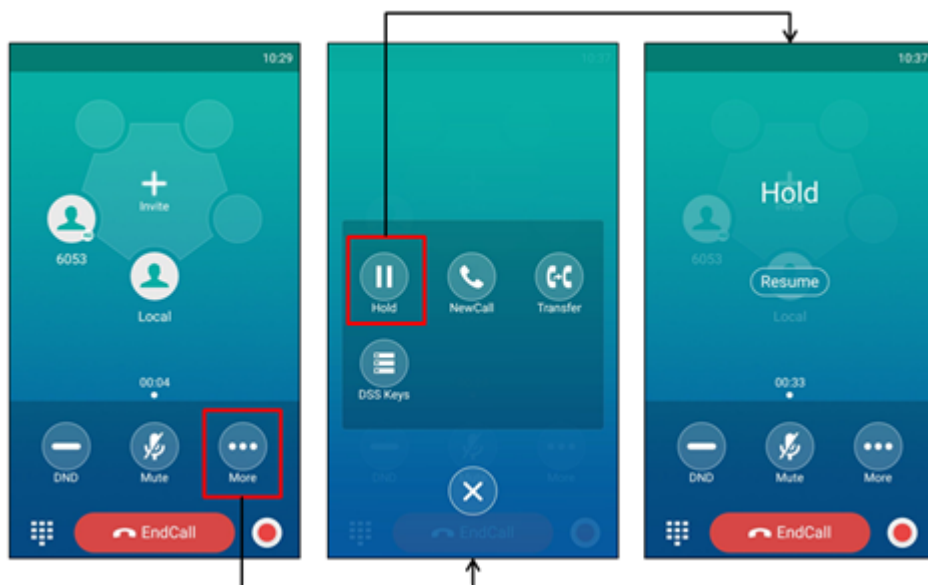

Note

When you have multiple calls on the phone and the current call is held, you can tap **Previous call/Next call** or swipe left/right to swap to the active call.

Resuming a Held Call

You can view and resume a held call on the phone.

Procedure

1. Tap **More** > **Resume** or .

If multiple calls are placed on hold, select the desired call first.

Note

When you have multiple calls on the phone and the current call is active, you can tap **Previous call/Next call** or swipe left to swap to the held call.

Redirecting Incoming Calls

When you are not available to answer calls on your phone, you can forward the calls to another phone.

Topics

[Forwarding All Incoming Calls to a Contact](#)



[Forwarding an Incoming Call Manually](#)

[Diverting Calls to a Contact](#)

Forwarding All Incoming Calls to a Contact

You can set up the phone to forward all incoming calls to a contact.

Procedure

1. Navigate to **Settings** > **Features** > **Call Forward**.
2. Tap the desired forwarding type.
 - **Always Forward**: Forwards all incoming calls.
 - **Busy Forward**: Forwards incoming calls when you're in a call.
 - **No Answer Forward**: Forwards all unanswered incoming calls.
3. Turn on the desired forwarding type.
4. Do one of the following:
 - Enter the number you want to forward to in the **Forward to** field.
 - Tap , and then tap the desired contact.
5. If you select **No Answer Forward**, tap the **After Ring Time** field to select the desired ring time to wait before forwarding.
6. Tap .

The icon  in the status bar indicates that the call forward is enabled.

Note

You can also enter the SIP URI or IP address in the **Forward to** field.

Forwarding an Incoming Call Manually

You can manually forward the call to another contact while your phone rings.

Procedure



1. When the phone is ringing, tap .
2. Enter the number you want to forward the incoming call to.
3. Tap **Forward**.

The phone prompts a call forward message.

Forwarding Incoming Calls with a Forward Key

When the phone receives an incoming call, you can easily tap the Forward key to forward the incoming call to a specific contact.

Procedure

1. Navigate to **Settings > Features > Dsskey**.
2. Select the desired line key.
3. Select **Key Event** from the **Type** field.
4. Select **Forward** from the **Key Type** field.
5. If your system administrator has set the forward mode to **Custom**, select the desired line from the **Account ID** field.
6. Do one of the following:
 - (Optional.) Enter the string that will display on the phone screen in the **Label** field.
Enter the contact number you want to forward the incoming calls to in the **Value** field.
 - Tap , and then tap the desired contact.
7. Tap .

Tips



By default, you can drag the line key to the **Edit** field to set it.

When the phone is ringing, tap the forward key to quickly forward the call to the specific contact.

Diverting Calls to a Contact

You can divert all incoming calls from a particular contact to another contact. Auto divert has precedence over call forward.

Procedure

1. Tap .
2. Tap  after the desired contact.
3. Edit the contact information.
4. Enter a contact's number you want to divert the call to in the **Auto Divert** field.
5. Tap .

Transferring Calls

During a call, you can transfer the call to another contact.

You can use one of three ways:

- **Blind Transfer:** Transfer a call directly to the third party without consulting.
- **Semi-Attended Transfer:** Transfer a call when receiving ringback.
- **Attended Transfer (Consultative Transfer):** Transfer a call with prior consulting.

Topics

Performing a Blind Transfer

Performing a Semi-Attended/Attended Transfer

Performing a Blind Transfer

You can transfer a call to another contact immediately without consulting with her/him first.

Topics

Performing a Blind Transfer

Performing a Blind Transfer



You can enter the number, or select a contact from directory or history to perform a blind transfer.

Procedure

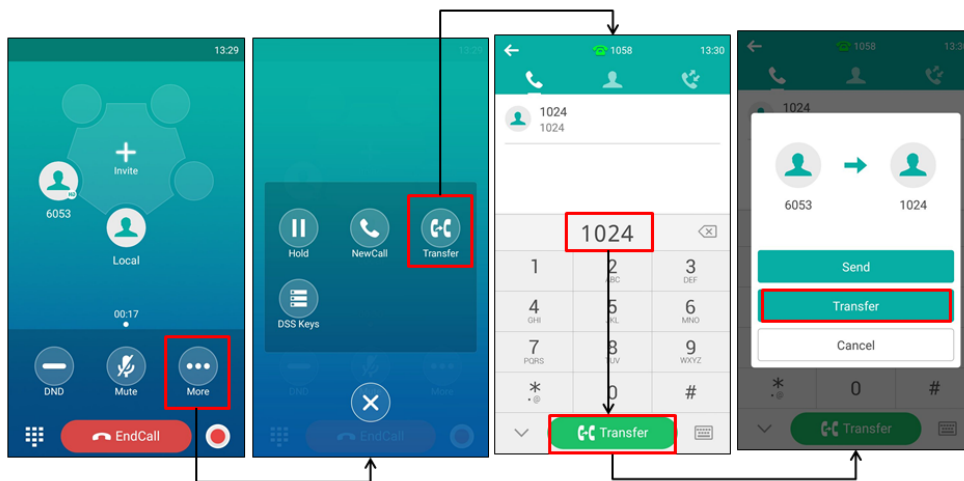
1. Tap **More** > **Transfer** during a call.
2. Do one of the following:
 - Enter the number you want to transfer the call to, and then tap **Transfer**.



Tap **Transfer** to complete the transfer. (The call will automatically dial out in about 5 seconds if you do not tap **Transfer**.)



- Tap , and then select the desired contact to complete the transfer.
- Tap , and then select the desired list. Tap the desired entry to complete the transfer.

Performing a Semi-Attended/Attended Transfer

You can transfer calls to other contacts immediately when receiving ringback or after consulting with them first.

Procedure

1. Tap **More** > **Transfer** during a call.
2. Do one of the following:
 - Enter the number you want to transfer the call to.
Tap **Transfer** > **Send** to dial out.

- Tap , and then select the desired contact to dial out.
 - Tap , and then select the desired entry to dial out.
3. Do one of the following:
- When you hear the ringback tone, tap **Transfer** to finish the semi-attended transfer.
 - After the contact answers the call, tap **Transfer** to finish the attended transfer (consultative transfer).

Conference Calls

The phone supports a five-way local conference and multi-way network conference.

During the conference, follow these tips:

- Mute your microphone when you are not speaking, especially in noisy environments.
- Avoid tapping or rustling papers near the microphone.
- Speak in your normal voice without shouting.

Topics

[Local Conference](#)

[Network Conference](#)

Local Conference

The CP960 phone supports up to five parties (including yourself) in a conference call.

There are three ways to create a conference:

- Initiating a conference by dialing multiple numbers.
- Initiating a conference by inviting participants.
- Merging multiple calls into a conference.

If you connect a mobile phone and PC to your IP phones, you can also create a hybrid UC conference.

The following figure shows what the phone screen looks like in a five-way conference call:

The avatar of the talking party shows water ripples

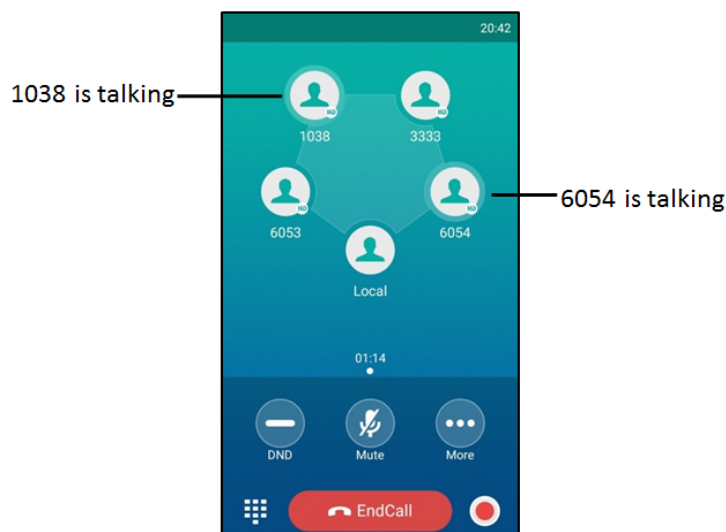

Topics

- [Initiating a Conference by Dialing Multiple Numbers](#)
- [Initiating a Conference by Inviting Participants](#)
- [Merging Multiple Calls into a Conference Call](#)
- [Creating a Hybrid UC Conference](#)
- [Holding/Resuming a Conference Call](#)
- [Muting/Unmuting a Conference Call](#)
- [Splitting a Conference Call](#)
- [Managing the Conference Participants](#)
- [Enabling/Disabling the DND Mode for a Conference Call](#)

Initiating a Conference by Dialing Multiple Numbers

You can initiate a conference by dialing multiple numbers, this is a convenient way to set up a local conference.

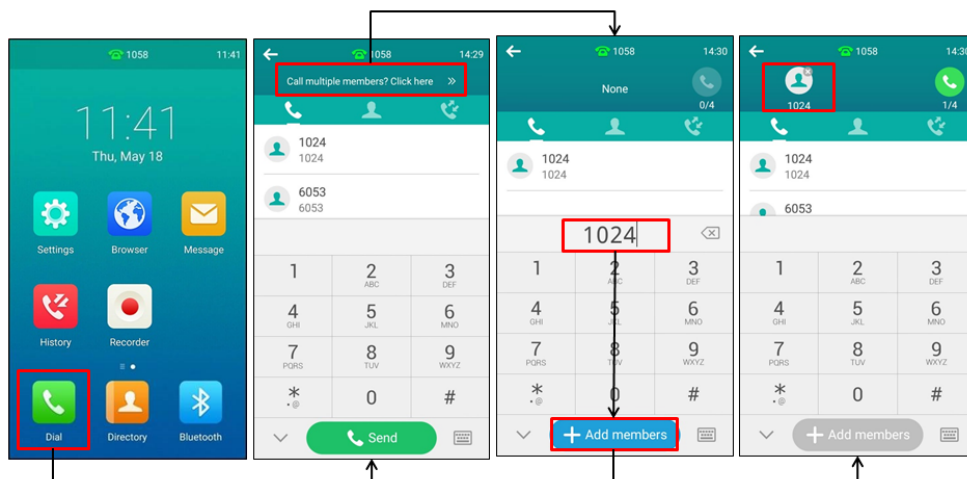

Procedure

1. Tap .
2. Tap **Call multiple members? Click here >>**.
3. Enter the number of the first party then tap **Add members** or select a contact from **Directory** or **History**.
The avatar of the first party appears on the top of phone screen. You can tap the avatar to cancel the addition.



4. Repeat the step 3 until you add all intended parties.
5. Tap  to call all intended parties at the same time.
The conference is set up after the intended parties answer the call.

Note

The value under the icon  indicates the number of parties you have added and the maximum number of the parties you can add. For example,  indicates you can add up to 4 parties and you have added 1 party.

Initiating a Conference by Inviting Participants

You can invite one or multiple members at a time to join the conference.



Procedure

1. Place a call to the first party.
2. After the first party answers the call, tap **Invite** or tap one of the empty round space.

3. Do one of the following:

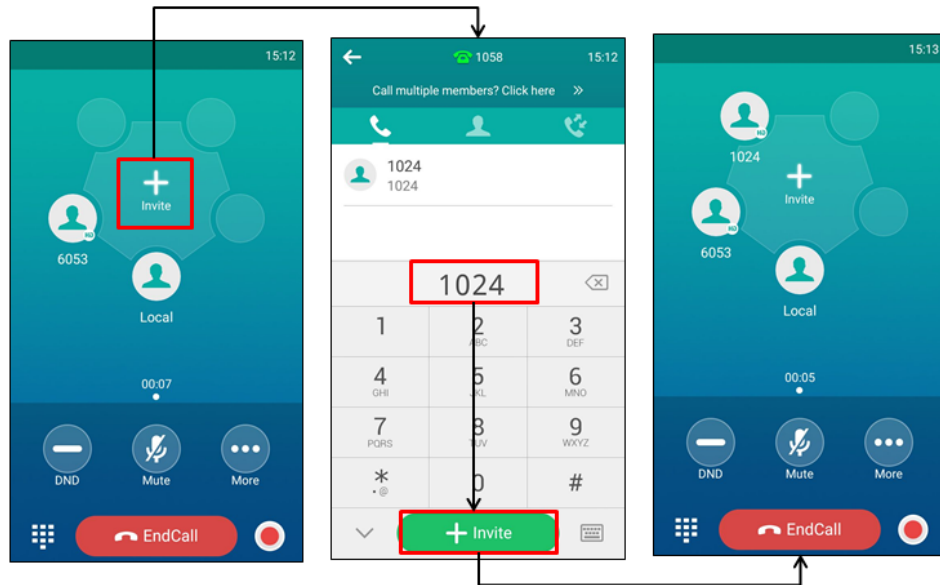
- Enter the number of the second party, and then tap **Invite**.
Repeat the step above until you add all intended parties.



- Tap , tap the desired contact to dial out.
- Tap , tap the desired history record to dial out.
- Tap **Call multiple members? Click here >>**.
Enter the number or select the contact, and then tap **Add members** to add multiple members.
Tap  to call all intended parties at the same time.

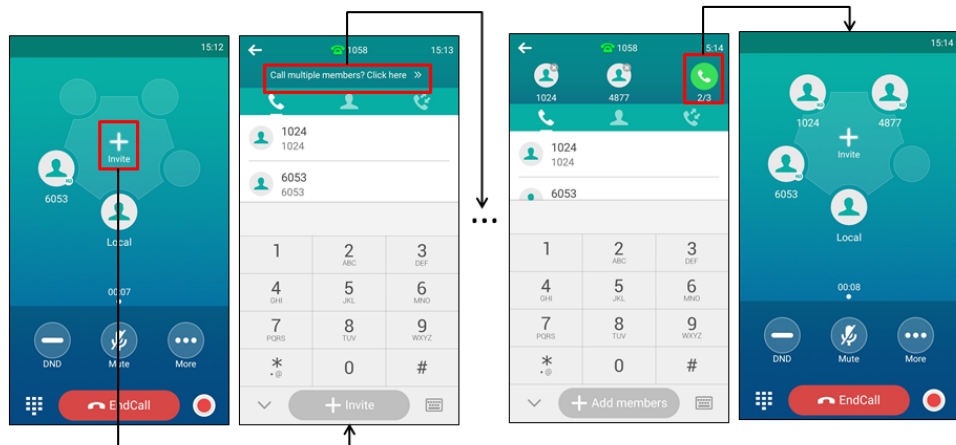

Merging Multiple Calls into a Conference Call

During the multiple calls, you can merge them into a conference call.

Procedure

1. Tap **Merge calls**.

The calls are merged into a conference call.

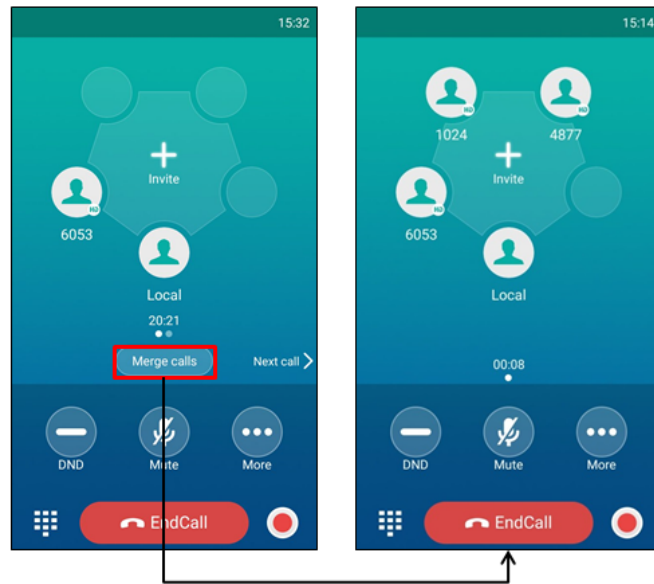

Creating a Hybrid UC Conference

You can merge the calls on your IP phones, the PC and connected mobile phone into a hybrid UC conference.

There are many ways to create a hybrid UC conference, the following shows an example.

Before You Begin

Make sure you have an active PC audio and connected a mobile phone to your phone.

Procedure

1. Tap **Invite** or tap one of the empty round space.
2. Do the following to place a mobile call over Bluetooth on the phone.
 - a. Enter the desired number and then tap **Invite**.
 - b. Select the connected mobile phone in the pop-up dialog box.
3. Tap **Invite** or tap one of the empty round space.
4. Do the following to place an IP call.
 - a. Enter the desired number and then tap **Invite**.
 - b. Select the registered account.

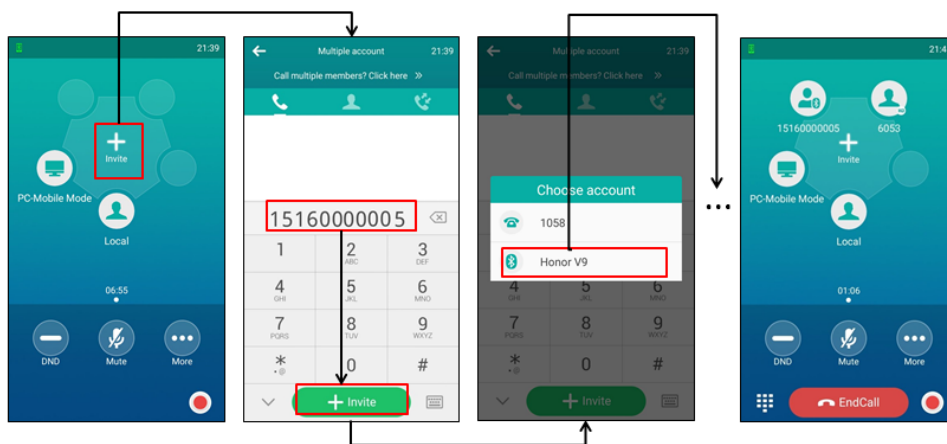

Related Topics

[Managing the Conference Participants](#)

[Managing the Conference Participants](#)

[Managing the Conference Participants](#)

Holding/Resuming a Conference Call

When you place a conference call on hold, both other participants are placed on hold. Other participants cannot hear each other until you resume the held conference call.

Procedure

1. Tap **More** > **Hold** to place the conference call on hold.
2. Tap **More** > **Resume** or tap  to resume the held conference call.

Muting/Unmuting a Conference Call

You can mute the local microphone during a conference call so that the other participants can hear each other except you.

Procedure

1. Tap **Mute** to mute the conference call.
2. Tap **Mute** again to unmute the conference.

Splitting a Conference Call

You can split the conference call into individual calls. After you split a conference call, the conference call ends, and other parties are held. You can resume the hold calls.

Procedure

1. Tap **More** > **Split** to split the conference call into individual calls on hold.

Managing the Conference Participants

During the conference, you can manage the participants to make the conference more flexible.

You can manage conference participants in the following ways:

- Mute a participant.
- Hold a participant
- Remove a participant from the conference
- Split the participant from the conference
- View the participant information

Procedure

1. Tap the avatar of desired participant, you can do the following:
 - Tap **Far Mute** to mute the participant. The muted participant can hear everyone, but no one can hear the muted participant.
 - Tap **Remove** to remove the participant from the conference.
 - Tap **Split** to split the participant from the conference.
 - Tap **Hold** to hold the participant.
 - Tap **Detail** to view the participant information.
 - Tap  to return to the conference screen.

Enabling/Disabling the DND Mode for a Conference Call

You can enable the DND mode for a conference call, as a result, the conference call will not be disturbed by the incoming calls.

Procedure

1. Tap **DND** to enable the DND mode.
2. Tap **DND** again to disable the DND mode.

Managing the Conference Participants

During the conference, you can manage the participants to make the conference more flexible.

You can manage conference participants in the following ways:

- Mute a participant.
- Hold a participant
- Remove a participant from the conference
- Split the participant from the conference
- View the participant information

Procedure

1. Tap the avatar of desired participant, you can do the following:
 - Tap **Far Mute** to mute the participant. The muted participant can hear everyone, but no one can hear the muted participant.
 - Tap **Remove** to remove the participant from the conference.
 - Tap **Split** to split the participant from the conference.
 - Tap **Hold** to hold the participant.
 - Tap **Detail** to view the participant information.
 - Tap  to return to the conference screen.

Network Conference

If your system administrator has set a network conference feature on your phone, you can initiate a conference with two or more contacts.

Topic

[Setting Up a Network Conference](#)

Setting Up a Network Conference

You can set up a network conference with multiple parties.

Procedure

1. Place a call to the first party.
2. When the first party answers the call, tap **Invite** or tap one of the empty round space.
3. Do one of the following:
 - Enter the number of the second party, and then tap **Invite**.
 - Tap **Call multiple members? Click here >>**, enter the number of the new party, and then tap **Add members**. Repeat the step above until you add all intended parties.
 Tap  to call all intended parties at the same time.

The conference is set up after the intended parties answer the call.

Note

The Procedures for setting up a network conference call on specific servers may be different from the introduction above. Contact your system administrator for more information.

Call Recording

You can record up to 12 hours in one file. By default, the recorded files are saved in the internal SD card.

You can connect a USB flash drive to your phone, and save the recorded audio to the connected USB flash drive.

Topics

- [Recording a Call](#)
- [Recording a Conference](#)
- [Setting a Mark When Recording a Call](#)
- [Stopping a Recording](#)
- [Checking Storage Space](#)

Recording a Call

You can record the important parts during an active call.

Important

Before call recording, especially those involving PSTN, it is necessary to know about the rules and restrictions of call recording in the country where you are.

It is also very important to inform all the call parties that you are recording and ask for their consent before recording the conversation.

Procedure

1. During a call, tap .
2. If a USB flash drive is connected, select where to save your recording.

In this example, the recording will be saved to USB flash drive.

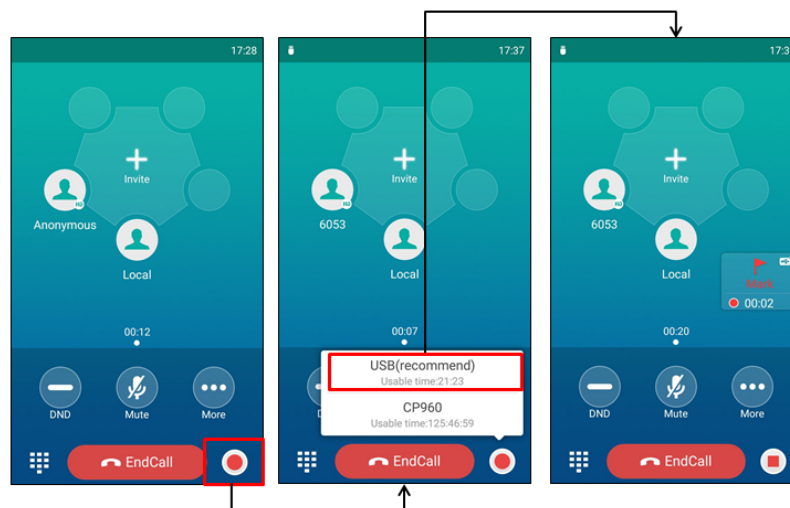

Recording a Conference

You can record conference calls in the same way as other calls. All conference participants are recorded while recording.

The following lists exceptions:

- If one of the participants holds the conference call, only that participant is recorded. When a conference call is placed on hold, recording of the conference is paused. You can place or answer other calls, which will be recorded in the same file. When the conference call is resumed, recording of the conference resumes.
- If one of the participants mutes the conference call, only that participant is not recorded.

Related Topics

[Recording a Call](#)

Setting a Mark When Recording a Call

You can set a mark when recording a call to mark the special moment. And there will be a red flag on this moment when playing the recorded file so that you can drag to the moment quickly.

Procedure

1. Tap .

The icon changes to , the number will increase if you set more marks.

Stopping a Recording

You can stop recording a call before the call ends. The recording also stops when the active call ends. The recording will be saved as "*.aac" file in the internal SD card or the USB flash drive automatically.

Procedure

1. Do one of the following:

- Tap .

The recording icon and recording duration disappears. The screen prompts a message that the call is recorded successfully.

- Tap **End Call**.

The recording icon and recording duration disappears, and the phone returns to the idle screen. The screen prompts a message that the call is recorded successfully.

Checking Storage Space

You can check the total space or available space of the phone or connected USB flash drive.

Procedure

1. Tap  to launch the **Recorder** application.
2. If you want to check the storage space of the USB flash drive, tap **USB**.

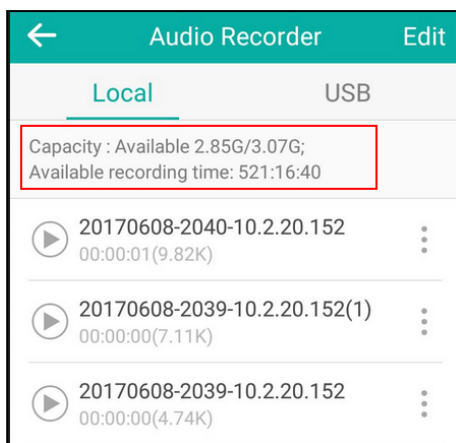

Multicast Paging

Multicast Paging allows you to broadcast instant audio announcements to users who are listening to a specific multicast group on a specific channel.

The phone supports the following 31 channels:

- **0:** Broadcasts are sent to channel 0. Note that the Yealink IP phones running old firmware version (old paging mechanism) can be regarded as listening to channel 0. It is the default channel.
- **1 to 25:** Broadcasts are sent to channel 1 to 25. We recommend that you specify these channels when broadcasting with Polycom IP phones which have 25 channels you can listen to.
- **26 to 30:** Broadcasts are sent to channel 26 to 30. We recommend that you specify these channels when broadcasting with Yealink IP phones running new firmware version (new paging mechanism).

Note

All IP phones in the multicast paging group must be deployed in the same subnet, since a broadcast is used. The phone can only send/receive broadcasts to/from the listened channels. Other channels' broadcasts will be ignored automatically by the IP phone.

Topics

- [Sending Multicast Paging](#)
- [Receiving Multicast Paging](#)
- [Managing a Paging Call](#)

Sending Multicast Paging

Your phone supports up to 31 groups for paging. You can assign a label to each group to identify the phones in the group, such as All, Sales, or HR.

You can set a line key as Multicast Paging key or Paging List key on the phone, which allows you to send announcements to the phones with pre-configured multicast address(es) on specific channel(s).

Note

Multicast RTP is one way only from the sender to the multicast address(es) (receiver). For outgoing RTP multicasts, all other existing calls on the phone will be placed on hold.

Topics

- [Setting a Multicast Paging Key](#)
- [Setting a Paging List Key](#)

[Sending Pages by a Paging List Key](#)

[Setting a Paging Group](#)

[Sending a Paging by a Multicast Paging Key](#)

[Deleting a Paging Group](#)

Setting a Multicast Paging Key

You can set a Multicast Paging key for a paging group, which allows you to send announcements quickly on the idle screen.

Before You Begin

Get the multicast IP address and port number from your system administrator.

Procedure

1. Navigate to **Settings > Features > Dsskey**.
2. Select the desired line key.
3. Select **Key Event** from the **Type** field.
4. Select **Multicast Paging** from the **Key Type** field.
5. (Optional.) Enter the paging group name in the **Label** field.
6. Enter the multicast IP address and port number (for example, 224.5.6.20:10008) in the **Value** field.
7. Enter the desired channel between 0 and 30 in the **Channel** field.
8. Tap  .

Tips

By default, you can drag the line key to the **Edit** field to set it.

Sending a Paging by a Multicast Paging Key

You can send a paging by using the Multicast Paging key when the phone is idle.

Before You Begin

You need to set a Multicast Paging key in advance.

Procedure

1. Tap the Multicast Paging key when the phone is idle.

Both your phone and receiver's phone play a warning tone and the multicast RTP session will be automatically answered on the receiver's phone in the speakerphone (hands-free) mode.

The following figure shows a multicast RTP session on the phone:

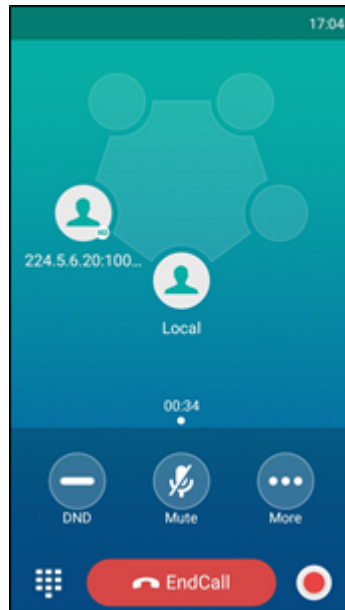

Related Topic

[Setting a Multicast Paging Key](#)

Setting a Paging List Key

You can set a Paging List key to easily access the paging groups on the idle screen.

Procedure

1. Navigate to **Settings > Features > Dsskey**.
2. Select the desired line key.
3. Select **Key Event** from the **Type** field.
4. Select **Paging List** from the **Key Type** field.
5. (Optional.) Enter the string that will display on the phone screen in the **Label** field.
6. Tap  .

Tips

By default, you can drag the line key to the **Edit** field to set it.

Setting a Paging Group

You can edit the information of the paging group.

Before You Begin

A Paging List key is set in advance. Get the multicast IP address and port number from your system administrator.

Procedure

1. Tap the Paging List key when the phone is idle.
2. Tap  after the desired paging group.

The default tag is Empty if it is not configured before.

3. Enter the multicast IP address and port number (for example, 224.5.6.20:10008) in the **Address** field.
4. Enter the string that will display on the phone screen in the **Label** field.
5. Enter the desired channel between 0 and 30 in the **Channel** field.
6. Tap .
7. To set more paging groups, repeat steps 2 to 6.

Sending Pages by a Paging List Key

You can send a paging by using the Paging List key when the phone is idle.

Before You Begin

You need to set a Paging List key in advance.

Procedure

1. Tap the Paging List key when the phone is idle.
2. Select the desired paging group.

Both your phone and receiver's phone play a warning tone and the multicast RTP session will be automatically answered on the receiver's phone in the speakerphone (hands-free) mode.

Related Topic

[Setting a Paging List Key](#)

Deleting a Paging Group

You can delete any group from the paging group list.

Procedure

1. Tap the Paging List key when the phone is idle.
If the Paging List key is not configured, you can also navigate to **Settings > Features > Paging List** to configure the paging list.
2. Tap  after the desired paging group.
3. Tap **Delete**.
The phone prompts you whether to delete the paging group.
4. Select **OK**.

If you want to delete all paging groups, you can tap  on the top-right of the phone screen.

Receiving Multicast Paging

Your system administrator has set a listening paging group for you, you can automatically receive a paging call when the phone is idle.



When there is a voice call or a paging call in progress, the phone handles the new paging call differently according to the multicast listening settings configured by your system administrator.

Managing a Paging Call

During a paging call, you can manage it manually at any time.

Procedure

- Tap **More > Hold** to place the current paging call on hold.
The paging call is placed on hold and the receiver releases the session.

- Tap **More** > **Resume** or  to resume the held paging call.
The multicast RTP session is re-established.
- Tap **DND** to enable or disable DND mode.
- Tap **Mute** to mute the multicast RTP session.
- Tap  to record a call.
- Tap **End Call** to end the paging call.

Advanced Call Features

You can perform some server-dependent tasks on the phone. Contact your system administrator to find out if your phone supports these advanced call features.

Topics

- [Using Call Completion](#)
- [Call Pickup](#)
- [Call Park](#)
- [Busy Lamp Field \(BLF\)](#)
- [BLF List](#)
- [Shared Line](#)
- [Intercom](#)
- [Voice Mail](#)
- [Using the Hot Desking](#)

Using Call Completion

When you call someone who is temporarily unavailable to answer the call, you can monitor the busy party and establish a call after the busy party becomes available to receive a call.

Note

Call completion is not available on all servers. For more information, contact your system administrator.

Procedure

1. Navigate to **Settings > Features > Call Completion**.
2. Turn on **Call Completion**.
3. Tap .

When you place a call and the callee is temporarily unavailable to answer the call, the phone prompts whether to wait for the callee, select **OK** to activate the call completion feature.

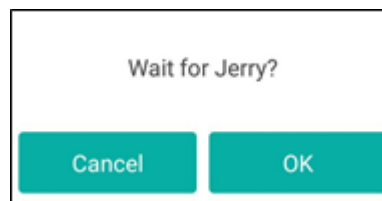

When the callee becomes idle, the phone prompts whether to dial the number, select **OK** to dial the number.

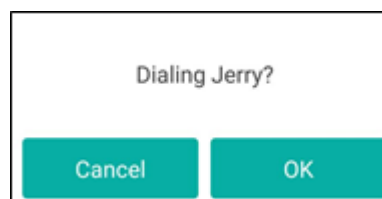

Call Pickup

You can use call pickup to answer someone else's incoming call on your phone.

The phone supports the following two call pickup features:

- **Directed Call Pickup:** allows you to pick up incoming calls to another phone.
- **Group Call Pickup:** allows you to pick up incoming calls to any phone within a predefined group.

Check with your system administrator to find out if this feature is available on your phone.

Topics

[Picking up a Call Directly](#)

[Picking up a Group Call Directly](#)

[Picking up a Call with a Directed Pickup Key](#)

[Picking up a Call with a Group Pickup Key](#)

Picking up a Call Directly

You can answer a call that rings on another phone.

Before You Begin

The target phone receives an incoming call. Your system administrator has enabled the directed call pickup and set the directed call pickup code.

Procedure

1. Tap  .
*The **DPickup** appears on the phone screen.*
2. Select **DPickup** on your phone.
3. Enter the phone number which is receiving an incoming call.
4. Select **DPickup** again.

The call is answered on your phone.

Tips

When the phone is idle, you can use a Directed Pickup or BLF/BLF List key to pick up a call to a specific contact directly.

Related Topics

[Picking up a Call with a Directed Pickup Key](#)

[Picking up a Remote Call by BLF Key](#)

[Picking up a Remote Call by BLF List Key](#)

Picking up a Group Call Directly

When any phone within a predefined group receives an incoming call, you can pick up that call on your phone.

If there are multiple incoming calls on the group at the same time, you can only pick up the first incoming call.

Before You Begin

Your system administrator has enabled the group call pickup and set the group call pickup code.

Procedure

1. Tap  .
*The **GPickup** appears on the phone screen.*
2. Select **GPickup** on your phone when any phone in the group receives an incoming call.

The call is answered on your phone.

Related Topic

[Picking up a Call with a Group Pickup Key](#)



Picking up a Call with a Directed Pickup Key

You can easily use a Directed Pickup key to pick up a call to a specific contact's phone.

Before You Begin

Ask your system administrator for the directed call pickup code.

Procedure

1. Navigate to **Settings > Features > Dsskey**.
2. Select the desired line key.
3. Select **Key Event** from the **Type** field.
4. Select **DPickup** from the **Key Type** field.
5. Select the desired line from the **Account ID** field.
6. Do one of the following:
 - (Optional.) Enter the string that will display on the phone screen in the **Label** field.
Enter the directed call pickup code followed by the specific extension in the **Value** field.
 - Tap , and then tap the desired contact.
7. Tap .

Tips

By default, you can drag the line key to the **Edit** field to set it.

When the target phone receives an incoming call, you can press the Directed Pickup key, and the call is answered on your phone.

Picking up a Call with a Group Pickup Key

You can easily select a Group Pickup key to pick up a group call.

Before You Begin

Check with your system administrator if the group call pickup code is required for this key. If required, get the group call pickup code from your system administrator.

Procedure

1. Navigate to **Settings > Features > Dsskey**.
2. Select the desired line key.
3. Select **Key Event** from the **Type** field.
4. Select **Group Pick Up** from the **Key Type** field.
5. Select the desired line from the **Account ID** field.
6. Do one of the following:
 - (Optional.) Enter the string that will appear on the phone screen in the **Label** field.
Enter group call pickup code in the **Value** field.

- Tap , and then tap the desired contact.

7. Tap .

Tips

By default, you can drag the line key to the **Edit** field to set it.

When any phone within a predefined group of phones receives an incoming call, you can tap the Group Pickup key, and the call is answered on your phone.

Call Park

You can use call park to place a call on hold, and then retrieve the call from another phone in the system (for example, a phone in another office or conference room).

Note

Call park is not available on all servers. Contact your system administrator for more information.

Topics

[Configuring a Call Park Key](#)

[Using Call Park Feature](#)



Configuring a Call Park Key

You need to set a call park key to park an active call.

Before You Begin

You should get the call park code from your system administrator.

Procedure

1. Navigate to **Settings > Features > Dsskey**.
2. Select the desired line key.
3. Select **Key Event** from the **Type** field.
4. Select **Call Park** from the **Key Type** field.
5. Select the desired line from the **Account ID** field.
6. Do one of the following:
 - (Optional.) Enter the string that will appear on the phone screen in the **Label** field.
Enter the contact number you want to dial out directly in the **Value** field.
You can also enter the contact number with the DTMF sequence that you want to send in the **Value** field. The contact number and DTMF sequence are separated by commas. One comma stands for 500 milliseconds. For example, **1234,,123#** means the phone dials out the number 1234 first, then after the call is set up for 1 second, it sends the DTMF sequence 123# to the remote party.
 - Tap , and then tap the desired contact.
7. Tap .

Using Call Park Feature

You can park an active call by tapping the pre-configured call park key on the phone, and dial the call park retrieve code to retrieve the parked call.

Before You Begin

Make sure you have configured a Call Park Key. Contact your system administrator for the call park retrieve code.

Procedure

1. During a call, tap **More > Dsskey**.
2. Tap the call park key.
3. If you want to retrieve the parked call, dial the call park retrieve code.

If the parked call is not retrieved within a period of time assigned by the system, the phone performing call park will receive a call back.

Related Topic

[Configuring a Call Park Key](#)

Busy Lamp Field (BLF)

You can monitor a specific remote line using a BLF key for status changes on the phone.

Topics

[State Indicator of Remote Line by BLF Key](#)

[Visual Alert for BLF Pickup](#)







[Setting a BLF Key](#)

[Picking up a Remote Call by BLF Key](#)

[Transferring a Call by BLF Key](#)

State Indicator of Remote Line by BLF Key

You can get the monitored line's status by viewing the icon indicator of the BLF key.

Icons	Description	Icons	Description
	The monitored line is idle	 (Flashing)	The monitored line is ringing.
 (Flashing)	The monitored line is dialing		The monitored line is busy or in a call.
	The monitored line places a call on hold		A call is parked to the monitored line.
	The monitored line fails to register or does not exist.		

Visual Alert for BLF Pickup

Your system administrator can configure your phone to display the call information when the specified monitored line receives an incoming call.

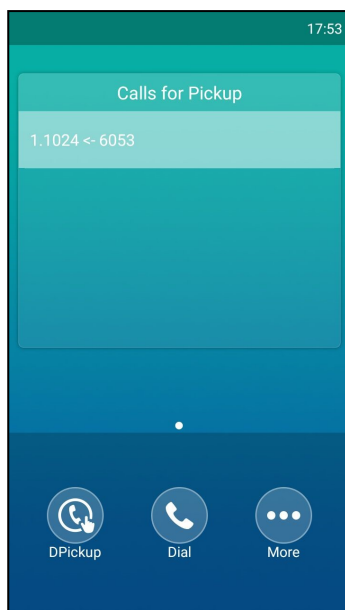

You can select to pick up the call to the monitored line, place a call to the monitored line, place a new call or go back to the idle screen.



Setting a BLF Key

You can set a BLF key to monitor a specific line for status changes on the phone.

Procedure

1. Navigate to **Settings > Features > Dsskey**.
2. Select the desired line key.
3. Select **BLF** from the **Type** field.
4. Select the desired line from the **Account ID** field.
5. Do one of the following:
 - (Optional.) Enter the string that will appear on the phone screen in the **Label** field.
Enter the phone number or the extension you want to monitor in the **Value** field.
 - Tap , and then tap the desired contact.
6. (Optional.) Enter the directed call pickup code in the **Extension** field.
7. Tap .

Tips

By default, you can drag the line key to the **Edit** field to set it.

Picking up a Remote Call by BLF Key

When the monitored users are not at their desks and someone rings their lines, you can pick up the desired call simply by tapping the flashing BLF key.

If your system administrator set the directed call pickup code in advance, you can use the BLF key to pick up the call directly. If not or if you want to set a pickup code for a specific BLF line, you can set a pickup code for BLF key manually.

Before You Begin

You have edited the BLF key's **Extension** field with the directed call pickup code from your system administrator.

Procedure

1. When the monitored line receives an incoming call, you can tap the BLF key to pick up the call for the monitored line directly.

Related Topic

[Setting a BLF Key](#)

Transferring a Call by BLF Key

When there is already an active call on the IP phones, you can transfer the active call to the monitored line by tapping the BLF key.

The phone transfers the active call differently depending on the Transfer Mode via Dsskey feature configured by your system administrator.

Topics

[Performing a Blind Transfer](#)

[Performing a Semi-attended/Attended Transfer](#)

Performing a Blind Transfer

During a call, you can transfer the call to the monitored contact in the blind-transfer way.

Before You Begin

Check with your system administrator if the Transfer Mode via Dsskey is set to **Blind Transfer**.

Procedure

1. During a call, tap **More > Dsskey**.
2. Tap the BLF key of the monitored user which you want to transfer this call to.

Performing a Semi-attended/Attended Transfer

During a call, you can transfer the call to the monitored contact in the semi-attended/attended-transfer way.

Before You Begin

Check with your system administrator if the Transfer Mode via Dsskey is set to **Attended Transfer**.

Procedure

1. During a call, tap **More > Dsskey**.
2. Tap the BLF key of the monitored user which you want to transfer this call to. The phone will dial out the number of the monitored line.
3. Tap the BLF key of the monitored user again to complete the transfer when the monitored user receives ringback or after the monitored user answers the call.

BLF List

BLF List feature enables you to monitor a list of users defined by your system administrator, and the respective icons will either flash or glow depending on the status of monitored lines.

Check with your system administrator to find out if this feature is available on your phone.

Topics

[State Indicator of Remote Line by BLF List Key](#)

[Visual Alert for BLF Pickup](#)

[Visual Alert for BLF Parked Call Monitor](#)

[Picking up a Remote Call by BLF List Key](#)







[Transferring a Call by BLF List Key](#)

[Retrieving a Call by a BLF List Key](#)

[Barging in an Active Call by BLF List Key](#)

State Indicator of Remote Line by BLF List Key

You can get the monitored line's status by viewing the icon indicator of the BLF List key.

Icons	Description	Icons	Description
	The monitored line is idle		The monitored line is ringing
	The monitored line is dialing		The monitored line is busy or in a call
	The monitored line places a call on hold		The monitored line fails to register or does not exist

Visual Alert for BLF Pickup

Your system administrator can configure your phone to display the call information when the specified monitored line receives an incoming call.

You can select to pick up the call to the monitored line, place a call to the monitored line, place a new call or go back to the idle screen.

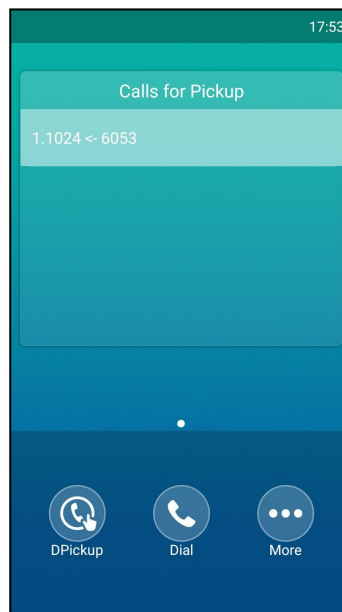

Visual Alert for BLF Parked Call Monitor

Your system administrator can configure your phone to display the call information when the specified monitored line receives an incoming call.

You can select to retrieve the call parked to the monitored line, place a call to the monitored line, place a new call or go back to the idle screen.

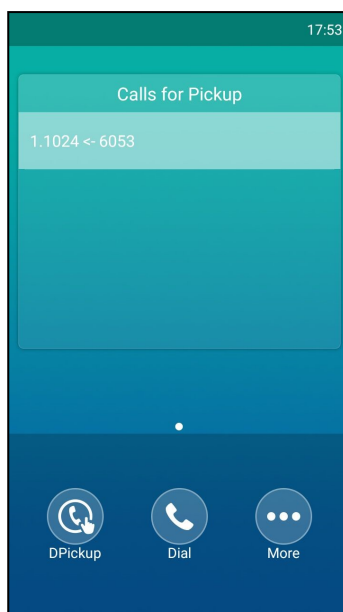

Picking up a Remote Call by BLF List Key

When the monitor user is not at his/her desk and someone rings his/her line, you can pick up the call simply by tapping the flashing BLF List key.

Before You Begin

Check with your system administrator to find out if this feature is available on your phone.

Procedure

1. Tap the BLF List key to pick up the call for the monitored line directly.

Transferring a Call by BLF List Key

When there is already an active call on the IP phones, you can transfer the active call to the monitored user by tapping the BLF List key.

The phone transfers (Blind Transfer or Attended Transfer) the active call differently depending on the Transfer Mode via Dsskey feature configured by your system administrator.

Topics

[Performing a Blind Transfer](#)

[Performing a Semi-attended/Attended Transfer](#)

Performing a Blind Transfer

During a call, you can use the BLF List key to perform a blind transfer to the monitored line.

Before You Begin

Check with your system administrator to make sure that the Transfer Mode via Dsskey is set to **Blind Transfer**.

Procedure

1. During a call, tap **More > Dsskey**.
2. Tap the BLF List key of the monitored user which you want to transfer this call to.

Performing a Semi-attended/Attended Transfer

During a call, you can use the BLF List key to perform a semi-attended/attended transfer to the monitored line.

Before You Begin

Check with your system administrator if the Transfer Mode via Dsskey is set to **Attended Transfer**.

Procedure

1. During a call, tap **More > Dsskey**.
2. Tap the BLF List key of the monitored user which you want to transfer this call to. The phone will dial out the number of the monitored line.
3. Tap the BLF List key of the monitored user again to complete the transfer when the monitored user receives ring-back or after the monitored user answers the call.

Retrieving a Call by a BLF List Key

You can use the BLF List key to retrieve a call which is parked to the monitored line.

Before You Begin

Check with your system administrator to find out if this feature is available on your phone.

Procedure

1. Tap the desired BLF List key to retrieve a call that is parked to the monitored line.

Barging in an Active Call by BLF List Key

You can use the BLF List key to barge in a conversation and set up a conference call.

Before You Begin

Check with your system administrator to find out if this feature is available on your phone.

Procedure

1. Tap the BLF List key.

The phone dials out the barge-in code followed by the monitored line, and then you can join the call. Each of the three parties can hear the other two parties.

Shared Line

Yealink phone supports using Shared Call Appearance (SCA) to share a line. So that this line can be registered on more than one phone at the same time.

Your system administrator can set your phone to use the shared line.

Topics

[State Indicator of Shared Line](#)

[Placing Calls on a Shared Line](#)

[Answering Calls on a Shared Line](#)

[Placing a Call on Public Hold](#)

[Placing a Call on Private Hold](#)

[Retrieving a Held Call on a Shared line](#)











[Barging in an Active Call on a Shared line](#)

[Pulling a Shared Call on a Shared line](#)

State Indicator of Shared Line

You can get the shared line's status by viewing the icon indicator of the shared line key.

The following table shows the all kinds of icon indicator associated with the shared line, and the corresponding descriptions:

Icons	Description	Icons	Description
	The shared line is idle.	 (Monitoring SCA Phone)	The shared line is seized.
 (Flashing)	The shared line receives an incoming call.	 (Flashing)	The shared line is dialing.
	The shared line is busy or is in a call.		The call on the shared line is placed on public hold.
	The call on the shared line is barged in by the other shared line user.	 (Local SCA Phone)  (Other Phone)	The call on the shared line is placed on private hold.
	In a multi-party call, place the call on hold locally.		

Placing Calls on a Shared Line

You can place one or multiple calls on a shared line.

The phone places a call on the first shared line key automatically. You can select the desired shared line key first and place a call using this key.

Related Topic

[Placing Calls](#)

Answering Calls on a Shared Line

You can answer one or more calls on the shared line.

When an incoming call arrives on the shared line, all the registered phones will ring simultaneously, and the call can be answered on any one of the phones. Incoming calls will be distributed evenly among the available shared line keys.

Note

If the number of incoming calls is greater than the configured line keys, the line keys will be used by sequence circulation. Contact your system administrator for more information.

Related Topic

[Answering Calls](#)

Placing a Call on Public Hold

You can place a call on public hold that any shared line phone can retrieve the held call.

Procedure

1. During a call, tap **More** > **Hold**.

Placing a Call on Private Hold

In SCA scenario, you can place a call on private hold that only you can retrieve the held call.

The **PriHold** soft key can be preset by your system administrator, you can also set a line key as the private hold key manually if the **PriHold** soft key is not available on your phone. You need to configure a private hold key before you place the call on private hold.

Procedure

1. Navigate to **Settings > Features > Dsskey**.
2. Select the desired line key.
3. Select **Key Event** from the **Type** field.
4. Select **Private Hold** from the **Key Type** field.
5. (Optional.) Enter the string that will display on the phone screen in the **Label** field.
6. Tap .

Tips

By default, you can drag the line key to the **Edit** field to set it.

During an SCA call, tap **More > Dsskey**, and then tap private hold key on the phone. Then the call is held on your phone, and the other phones registered with shared line show the call is in the busy state on the shared line key. Other users on the shared line cannot resume your held call.

Retrieving a Held Call on a Shared line

If you place a call on hold on a shared line, you can resume this call at any time.

Before You Begin

There is at least one call placed on public hold on the shared line.

Procedure

1. Do one of the following:
 - Tap .
 - Long tap the desired line key.
Tap **More > Retrieve** to retrieve the call.

Barging in an Active Call on a Shared line

In SCA scenario, you can barge into an active call on the shared line. After you barges into a call, the call turns into a three-party conference.

Note

Only one user can barge into an active call on the shared line at a time.

Before You Begin

There is at least one active call on the shared line.

Procedure

1. Long tap the desired line key.

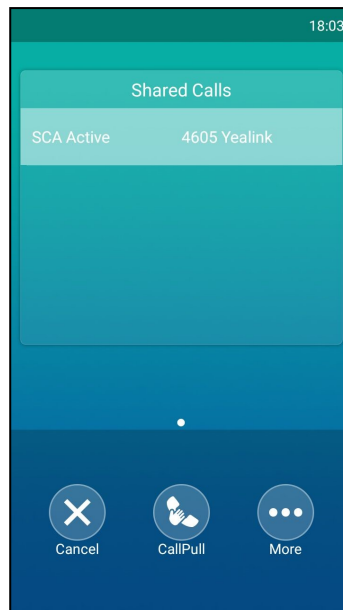

2. Select **More** > **Barge In** to interrupt the active call.

Pulling a Shared Call on a Shared Line

In SCA scenario, both you and other users can pull an existing call from another shared phone that is an active or hold state.

Check with your system administrator to find out if this feature is available for your phone.

Before You Begin

There is an active or held call on the shared line.

Procedure

1. Long tap the shared line key.

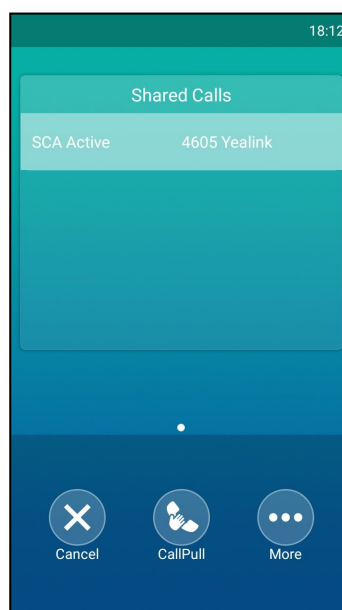

2. Tap **CallPull** to pull the call.

Intercom

Intercom is a useful feature in an office environment to quickly connect with the operator or the secretary.

Intercom enables you to place an intercom call that is answered automatically on the contact's phone as long as the contact is not in an active call.

Note

Intercom is not available on all servers. Contact your system administrator for more information.

Topics

[Placing an Intercom Call](#)

[Picking up an Incoming Call of the Target Extension](#)

[Answering an Intercom Call](#)

State Indicator of the Intercom key



can get the intercom status by viewing the icon indicator of the Intercom key.

Placing an Intercom Call

You can place an intercom call to quickly relay a message to a contact.

The target phone plays a warning tone and automatically answers the call in speakerphone (hands-free) mode by default. When the target phone has an active call, the intercom call is answered automatically after the active call ends.

Procedure

1. Navigate to **Settings > Features > Dsskey**.
2. Select the desired line key.
3. Select **Intercom** from the **Type** field.
4. Select the desired line from the **Account ID** field.
5. Do one of the following:
 - (Optional.) Enter the string that will appear on the phone screen in the **Label** field.
Enter the target extension number in the **Value** field.
 - Tap , and then tap the desired contact.
6. Tap .
7. Tap the Intercom key to place an intercom call.

Tips

By default, you can drag the line key to the **Edit** field to set it.

Related Topic

[Setting a BLF Key](#)

Picking up an Incoming Call of the Target Extension

You can pick up the target extension's incoming call by pressing the Intercom key.

Before picking up an incoming call, make sure that the directed call pickup code has been configured either for an Intercom key or for Call Pickup feature in advance.

Check with your system administrator to find out if this feature is available on your phone.

Note

If the directed call pickup code is not set, the phone will place a call to the target extension instead of picking up an incoming call of the target extension when you tap the Intercom key.

Before You Begin

Get the directed call pickup code from your system administrator.

Procedure

1. Drag the Intercom key to the **Edit** field.
2. Enter the directed call pickup code in the **Extension** field.
3. Tap .

When the target extension receives an incoming call, the Intercom key icon of the target extension will change to . Tap the Intercom key to pick up the incoming call directly.

Answering an Intercom Call

By default, when there is an incoming intercom call, the phone plays a warning tone and automatically answer the incoming call.

If your phone is set to answer intercom calls with your microphone muted, you need to tap the Mute key to unmute your microphone before responding to the call.

You can configure the following behaviors when receiving an intercom call.

Intercom Allow

Intercom Allow feature allows the phone to automatically answer an incoming intercom call. If you disable this feature, the phone will reject incoming intercom calls and send a busy message to the caller.

Note

Your system administrator can set a period of delay time before the phone automatically answers intercom calls.

Intercom Mute

Intercom Mute feature allows the phone to mute the microphone when incoming intercom calls are answered automatically.

Intercom Tone

Intercom Tone feature allows the phone to play a warning tone before answering an intercom call automatically.

Intercom Barge

Intercom Barge allows the phone to automatically answer an incoming intercom call while an active call is in progress. The active call will be placed on hold. If you disable this feature, the phone will handle an incoming intercom call like a normal incoming call while there is already an active call on the phone.

Note

To enable the phone to receive a new incoming call when it already has an active call, make sure that the call waiting feature is enabled on the phone in advance.

Procedure

1. Navigate to **Settings > Features > Intercom**.
2. Make the desired changes.
3. Tap .

Related Topics

[Muting or Unmuting the Microphone](#)
[Answering a Call When in a Call](#)

Voice Mail

Voice mail feature allows you to leave voice mails for someone or listen to your voice mail messages on your phone. This feature is set up on the server side and not all servers support this feature.

Topics

[Setting the Voice Mail Code](#)
[Leaving Voice Mails](#)
[Listening to Voice Mails](#)



Setting the Voice Mail Code

If you want to connect your phone to the message center, you need to set the voice mail code on your phone.

Before You Begin

Get the voice mail code from your system administrator.

Procedure

1. Tap  to launch **Message**.
2. Tap **Set Voice Mail**.
3. Enter the voice mail code (for example, *4) in the desired account field.
4. Tap .

Leaving Voice Mails

You can leave a voice mail to someone who is busy or inconvenient to answer the call.

Procedure

1. Follow the voice prompts to leave a voice mail.
2. Hang up to complete the voice mail.

Listening to Voice Mails

You can listen to your voice mails on the phone, to obtain a voice information sent by a contact.

Before You Begin

You need to set the voice mail code in advance.

Procedure

1. Tap  to launch **Message**.
2. Tap **View Voice Mail**.

The phone screen displays the amount of new and old voice mails. You can tap the account to listen to voice mails.

Tips

When The phone prompts that the phone receives a new voice mail, you can tap **Connect** to dial out the voice mail access code directly.

Related Topic

[Setting the Voice Mail Code](#)

Using the Hot Desking

You can use hot desking to log out from the current account and then log into a new account. So many users can share one phone resource at different times.

Note

Hot desking is not available on all servers. Contact your system administrator for more information.

Before You Begin

Your system administrator has set a Hot Desking key for you to use this feature. Get the login account information from your system administrator.

Procedure

1. Tap the hot desking key from the DSS key screen.

The phone prompts you whether to clear the account configuration.

2. Select **OK**.

Registration configurations of all accounts on the phone will be cleared immediately.

The login wizard will be displayed.

3. Enter the login information.

4. Tap .

Directory

The phone provides several types of phone directories, which can be customized by your system administrator.

Topics

[Local Directory](#)

[Blacklist](#)

[Remote Phone Book](#)

Local Directory

You can store up to 1000 contacts and 48 groups in your local directory, you can search, add, edit and delete a contact.

Topics

[Managing the Local Directory Groups](#)

[Managing the Local Directory Contacts](#)

[Moving a Local Directory Contact to Blacklist](#)

[Searching for Contacts](#)

Managing the Local Directory Groups

You can manage the Local Directory groups when the phone is idle.

Topics

[Adding Contact Groups](#)



[Editing Contact Groups](#)

[Deleting Contact Groups](#)

Adding Contact Groups

To organize your contacts and make them easier to find, you can add additional groups in the Local Directory.



Procedure

1. Tap  > **Local Directory**.
2. Tap  after **Custom Grouping**.
3. Enter the desired group name.
4. Tap **OK**.

Editing Contact Groups

You can change or add the group's information.



Procedure

1. Tap  > **Local Directory**.
2. Tap  after the desired group and then tap **Rename**.
3. Edit the group name.
4. Tap **OK**.

Deleting Contact Groups

When you delete a contact group, the contacts in the group will not be deleted. You can view the contacts in **All Contacts** list.

Procedure

1. Tap  > **Local Directory**.
2. Tap  after the desired group and then tap **Delete**.
The phone prompts you whether to delete the group.
3. Select **OK**.

Managing the Local Directory Contacts

You can manage the Local Directory contacts when the phone is idle.



Topics

- [Adding Contacts](#)
- [Viewing Contacts](#)
- [Editing Contacts](#)
- [Deleting a Contact](#)
- [Deleting All Contacts](#)

Adding Contacts

When you add a contact to your Local Directory, you can choose how much information you want to enter for your contact. You are required to enter a contact name at least for each new contact.

Procedure

1. Tap .
2. If you want to add a contact to the specified contact group, tap **Local Directory** to select the desired contact group.
3. Tap .
4. Enter your contact's information.
5. Tap the desired account from the **Account** field.
6. Tap the desired photo from the **Photo** field.
7. Tap .

Viewing Contacts

You can view the local contacts from the Local Directory on your phone.



Procedure

1. Tap .
2. If you want to view a contact to the specified contact group, tap **Local Directory** to select the desired contact group.
The contact names are displayed in alphabetical order.

Editing Contacts

You can update your contacts' information.



Procedure

1. Tap .
2. If you want to edit a contact from the specified contact group, tap **Local Directory** to select the desired contact group.
3. Tap  after the desired contact.
4. Edit the contact information.
5. Tap .

Deleting a Contact

You can delete any contact from the Local Directory.



Procedure

1. Tap .
2. If you want to delete a contact from the specified contact group, tap **Local Directory** to select the desired contact group.
3. Tap  after the desired contact.
4. Tap **Delete**.
The phone prompts you whether to delete the contact.
5. Tap **OK**.

Deleting All Contacts

You can delete all contacts from the Local Directory.



Procedure

1. Tap .
2. Long tap a contact.
3. Tap the radio box in the top right of the screen.
4. Tap  > **Delete contacts**.
The phone prompts you whether to delete all contacts.
5. Select **OK**.

Moving a Local Directory Contact to Blacklist

You can move a contact in the Local Directory to blacklist. Incoming calls from this contact will be rejected automatically.

Procedure



1. Tap .
2. If you want to select a contact to the specified contact group, tap **Local Directory** to select the desired contact group.
3. Tap  after the desired contact.
4. Tap **Blacklist**.
The phone prompts you whether to move this contact to the blacklist.

5. Tap **OK**.

Searching for Contacts

In the Local Directory, you can enter search criteria to find your desired contact quickly.

Procedure

1. Tap .
2. Do one of the following:
 - Tap . Enter your search criteria in the search field.
 - Tap the desired letter (e.g., T) along the right side to jump to contacts whose names start with T or t.

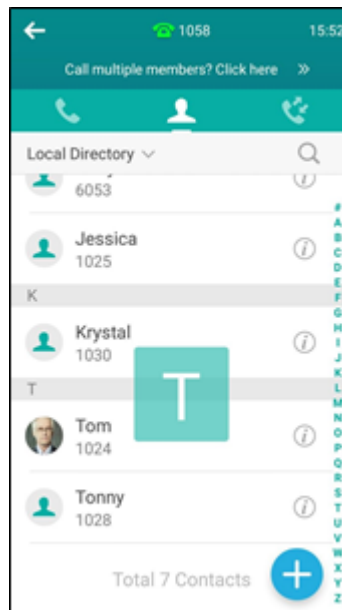

Blacklist

Incoming calls from the Blacklist are rejected automatically. You can store up to 30 contacts in the blacklist to block unwanted callers.

Topics

[Adding a Blacklist Contact](#)

[Viewing Blacklist Contacts](#)

[Editing a Blacklist Contact](#)

[Deleting Blacklist Contacts](#)



[Moving a Blacklist Contact to the Local Directory](#)

Adding a Blacklist Contact

You can add a blacklist contact on the phone to prevent someone from calling you.

Procedure

1. Navigate to  > **Local Directory** > **Blacklist**.

2. Tap .
3. Enter the blacklist contact's information.
4. Tap .

Viewing Blacklist Contacts

You can view the blacklist contacts from the Blacklist on your phone.



Procedure

1. Navigate to  > **Local Directory** > **Blacklist**.

Editing a Blacklist Contact

You can update your blacklist contacts' information.

Procedure

1. Navigate to  > **Local Directory** > **Blacklist**.
2. Tap  after the desired contact.
3. Edit the blacklist contact information.
4. Tap .

Deleting Blacklist Contacts

You can delete one or all blacklist contacts. If a contact is removed from the blacklist, you can answer the call from the contact normally.

Topics



[Deleting a Blacklist Contact](#)

[Deleting All Blacklist Contacts](#)

Deleting a Blacklist Contact

If you want to answer a call from a specific contact, you need to remove it from the Blacklist.

Procedure

1. Navigate to  > **Local Directory** > **Blacklist**.
2. Tap  after the desired contact.
3. Tap **Delete**.
The phone prompts you whether to delete the contact.
4. Select **OK**.

Deleting All Blacklist Contacts

You can delete all contacts from the Blacklist when you are ready to answer calls from them again.

Procedure

1. Navigate to  > **Local Directory** > **Blacklist**.
2. Long tap a contact.

3. Tap the radio box on the top-right of the screen.

4. Tap  > **Delete contacts**.

The phone prompts you whether to delete all contacts.

5. Tap **OK**.

Moving a Blacklist Contact to the Local Directory

You can move a blacklist contact to a Local Directory. Incoming calls from this contact will not be rejected automatically.

Procedure

1. Navigate to  > **Local Directory** > **Blacklist**.

2. Tap  after the desired contact.

3. Select **Local Directory** from the **Group** field.

4. Tap .

Remote Phone Book

If the Remote Phone Book feature has been enabled by your system administrator, you can access your corporate directory directly from your phone.

Topics

[Searching for Remote Phone Book Contacts](#)

[Viewing Remote Phone Book Contacts](#)

[Saving a Remote Phone Book Contact to the Local Directory](#)

[Saving a Remote Phone Book Contact to the Blacklist](#)

Searching for Remote Phone Book Contacts

In the Remote Phone Book, you can enter search criteria to find your desired contact quickly.

Procedure

1. Tap  > **Local Directory** > **Remote Phone Book**.

2. Do one of the following:

- Tap .

Enter your search criteria in the search field.

- Tap the desired letter (e.g., T) along the right side to jump to contacts whose names start with T or t.

Viewing Remote Phone Book Contacts

You can view the contact list of the remote phone book on your phone.



Procedure

1. Tap  > **Local Directory** > **Remote Phone Book**.

Saving a Remote Phone Book Contact to the Local Directory

You can save any remote phone book contact to the Local Directory, to conveniently call this contact when you cannot access the remote phone book.



Procedure

1. Tap  > **Local Directory** > **Remote Phone Book**.
2. Tap the desired remote phone book.
3. Tap  after the desired contact.
4. Tap **Add**.
5. Select **Local Directory** from the **Group** field.
6. Tap .

Saving a Remote Phone Book Contact to the Blacklist

You can save any remote phone book contact to the Blacklist on the phone, to prevent this contact from calling you.

Procedure

1. Tap  > **Local Directory** > **Remote Phone Book**.
2. Tap the desired remote phone book.
3. Tap  after the desired contact.
4. Tap **Add**.
5. Select **Blacklist** from the **Group** field.
6. Tap .

Call History

The call history list includes Missed Calls, Placed Calls, Received Calls and Forwarded Calls, and each list holds 100 entries.

Topics

[Call History Icons](#)

[Viewing History Records](#)

[Saving a History Record to Local Directory](#)





[Saving a History Record to Blacklist](#)

[Deleting History Records](#)

[Disabling History Record](#)

Call History Icons



Each icon in the Call History indicates the corresponding call history status.

Icons	Description	Icons	Description
	Received Call		Missed Call
	Placed Call		Forwarded Call

Viewing History Records

The history record saves the call information such as the caller's name and number, local line and call duration.



Procedure

1. Tap  or navigate to **Menu > History**.
2. Tap **Local Calls** to select the desired list.
3. Tap  after the desired entry.

Saving a History Record to Local Directory

To identify someone's call the next time, you can save a history record to the Local Directory.



Procedure

1. Tap .
2. Tap **Local Calls** to select the desired list.
3. Tap  > **Add**.
4. Edit the contact information.
5. Tap .

Saving a History Record to Blacklist

You can prevent someone from calling you again by saving a history record to Blacklist.

Procedure

1. Tap .
2. Tap **Local Calls** to select the desired list.
3. Tap  > **Blacklist**.
4. Edit the contact information.
5. Tap .

Deleting History Records

You can delete one or all call records from the call history list.

Topics



[Deleting a Call Record](#)

[Deleting All Call Records](#)

Deleting a Call Record

You can delete any call record from the call history list.



Procedure

1. Tap  or navigate to **Menu > History**.
2. Tap **Local Calls** to select the desired list.
3. Tap  after the desired entry, and then tap **Delete**.
The phone prompts you whether to delete the record.
4. Tap **OK**.

Deleting All Call Records

You can delete all call records from the call history list.

Procedure

1. Tap .
2. Tap **Local Calls** to select the desired list.
3. Long tap a contact.
4. Tap the radio box on the top-right of the screen.
5. Tap  > **Delete calls**.
The phone prompts you whether to delete all the records.
6. Tap **OK**.

Disabling History Record

If you disable history record, you cannot save any call log on the phone.

Procedure

1. Navigate to **Settings > Features > History Record**.
2. Turn off **History Record**.
3. Tap .

System Applications

The system applications are pre-installed on your phone and they cannot be uninstalled.

Topics

[Recorder](#)
[Browser](#)
[Clock](#)

Recorder

You can use the **Recorder** to record audio and manage the recording.

During recording, you can mark specific moments so that you can quickly find and listen to them later. You can record up to 12 hours in one file. The recording is saved in "*.amr" format with the name consisting of a prefix "record@" and date & time stamp.

Topics

[Recording Audio](#)
[Playing the Recorded Audios](#)
[Pause/Resuming a Playback](#)
[Fast Forwarding/Rewinding a Playback](#)
[Stopping a Playback](#)
[Copying Recorded Audio to USB Flash Drive](#)
[Recording Audio](#)
[Renaming the Recording](#)
[Deleting a Recording](#)
[Deleting All Recordings](#)
[Checking Storage Space](#)





Recording Audio

By default, the recorded audio is saved in the internal SD card. You can connect a USB flash drive to your phone, and save the recorded audio to it.

Note

For more information on how to attach a USB flash drive, please refer to the Quick Start Guide for your phone on [Yealink Support](#).

Procedure

1. Tap  to launch the **Recorder**.
2. If you have inserted a USB flash drive, tap **USB** to save the recorded audio to USB flash drive.
3. Tap  to start recording.
4. You can do one of the following:
 - Tap  to pause the recording.
 - Tap  to set a mark.

The icon changes to , the number will increase if you set more marks.

And there is a red flag on this moment when playing.

5. Tap  to end the recording and save the recording.

The recorded audio will be displayed on the right list automatically.

Playing a Recorded Call



You can browse and play back the recordings on your phone.

The recorded calls saved in "*.aac" format and include a date & time stamp and the other party's number/IP address/-name (or the first person's number/IP address/name you called), for example, 20170515-1452-Tom was created on May 15, 2017, at 14:52 and you have a call with Tom.

Tips

You can also play back the recorded calls on the phone or on a computer using an application compatible of playing ".aac" files.

Procedure

1. Tap  to launch the **Recorder**.
2. If you want to play the recorded audio saved in USB flash drive, tap **USB**.
3. Tap  before the desired recorded call to play the recorded call.

The length of the recording and a progress bar are displayed as the recording plays.



You can tap the Volume key to adjust the volume of audio output.

Related Topics

Pause/Resuming a Playback

When you receive an incoming call while playing a recording, the recording is paused automatically. You can resume the playback after handling the call. You can also pause the recording manually at any time.

Procedure

1. Tap  to pause playing the recording. The icon  appears on the phone screen.
2. Tap  to resume the playback.

Fast Forwarding/Rewinding a Playback

While a recorded file plays, you can fast forward or rewind the playback at any time.

Procedure

1. Drag the slider to skip forward the playing or rewind the playing.
If you have set marks for the recorded audio, you can drag the slider to the position with a red flag to listen to the marked moments.

Stopping a Playback

While a recording plays, you can stop playing it at any time.

Procedure

1. Tap  to stop the playing.



Copying Recorded Audio to USB Flash Drive

You can copy any recorded audio stored in **Recorder** application to your USB flash drive, as a result, you can view it on PC or other devices.

Before You Begin

Before copying recorded audio to USB flash drive, you should connect a USB flash drive first.

Procedure

1. Tap  to launch the **Recorder** application.
2. Tap  after the desired recorded audio.
3. Tap **Copy to USB**.

If the recorded audio is copied successfully, the phone screen will prompt "Copy successfully".

The prompt "XX Copied" (XX indicates the date when the recorded audio is copied to the USB flash drive) appears under the corresponding recorded audio.

Copying All Recorded Audio to USB Flash Drive

You can copy all recorded audio to your USB flash drive, as a result, you can view them on PC or other devices.

Before You Begin

Before copying recorded audio to USB flash drive, you should connect a USB flash drive first.

Procedure



1. Tap  to launch the **Recorder** application.
2. Tap **Edit**.
3. Check the radio box on the top-left of the screen to select all recordings.
4. Tap **Copy to USB**.

The prompt "XX Copied" (XX indicates the date when the recorded audio is copied to the USB flash drive) appears under the corresponding recorded audio.

Renaming the Recording

You can rename the recording for better recognition.

Procedure

1. Tap  to launch **Recorder**.
2. If you want to rename the recorded audio saved in USB flash drive, tap **USB**.
3. Tap  after the desired recording.
4. Tap **Rename**.
5. Enter the desired file name.
6. Tap **OK**.

Deleting a Recording

You can delete local recordings or call recordings from **Recorder**. The local recording is named with a prefix "record@" and date & time stamp, while the call recordings are named with the date & time stamp.

Procedure

1. Tap  to launch the **Recorder**.

*The phone shows all recordings in the **Audio Recorder** list.*

2. If you want to delete the recorded audio saved in USB flash drive, tap **USB**.
3. Tap  after the desired recorded audio.
4. Tap **Delete**.

The phone prompts you whether to delete the audio.

5. Tap **OK**.

Deleting All Recordings

You can delete all the recording when you need additional space.

Procedure

1. Tap  to launch **Recorder**.

*The phone screen shows all recorded files in the **Audio Recorder** list.*

2. If you want to delete the recorded audio saved in USB flash drive, tap **USB**.
3. Tap **Edit**.
4. Check the radio box on the top-left of the screen to select all recordings.

The phone prompts you whether to delete all the audio files.

5. Tap **OK**.

Checking Storage Space

You can check the total space or available space of the phone or connected USB flash drive.

Procedure

1. Tap  to launch the **Recorder** application.
2. If you want to check the storage space of the USB flash drive, tap **USB**.

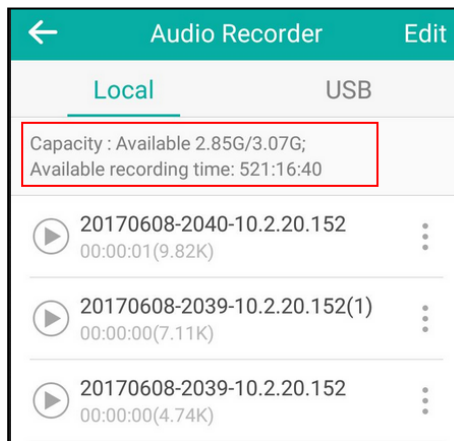

Browser

The use of **Browser** is similar to PC's web browser, which allows you to browse web pages, set bookmarks, set home pages, clear history records, and so on.

Topics

[Browsing a Web Page](#)
[Managing Bookmarks](#)
[Setting a Home Page](#)
[Clearing the Navigation History](#)
[Modifying the Browser Settings](#)

Browsing a Web Page

You can use the **Browser** just like normal browsers to browse websites.

Procedure

1. Tap  to launch the **Browser**.
2. Enter a part of URL in the address input field of the browser.
The phone will automatically retrieve and list similar websites.
3. Tap the website you want to visit, or enter the full URL then tap **Go** on the onscreen keyboard to browse the web page.

Managing Bookmarks

You can bookmark the web pages that you frequently visit.



Topics

[Adding a Web Page to the Bookmarks Library](#)
[Accessing a Web Page from the Bookmarks Library](#)
[Editing a Bookmark](#)
[Deleting a Bookmark](#)

Adding a Web Page to the Bookmarks Library

You can bookmark a web page so you can access it from the Bookmarks Library directly.

Procedure

1. Tap  to launch the **Browser**.
2. Access the web page you want to bookmark.
3. Tap  > **Save to bookmarks**.

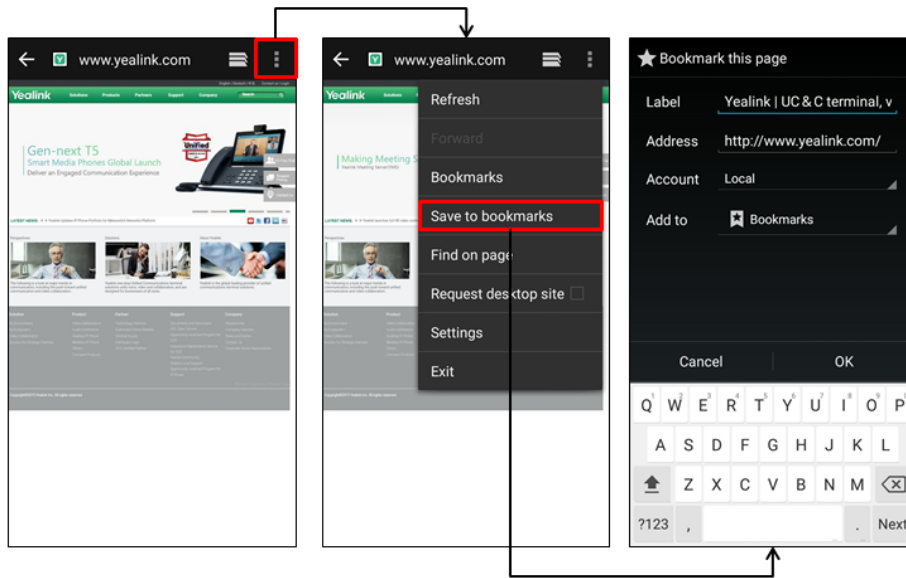

4. Edit the details of your bookmark.

5. Tap **OK**.



*The web page is added to the **BOOKMARKS** Library.*

Accessing a Web Page from the Bookmarks Library

You can quickly visit the web page from the Bookmarks Library.

Procedure

1. Tap  to launch the **Browser**.

2. Tap  >  to access the **BOOKMARKS** list.

A list of web pages that you've bookmarked will appear.

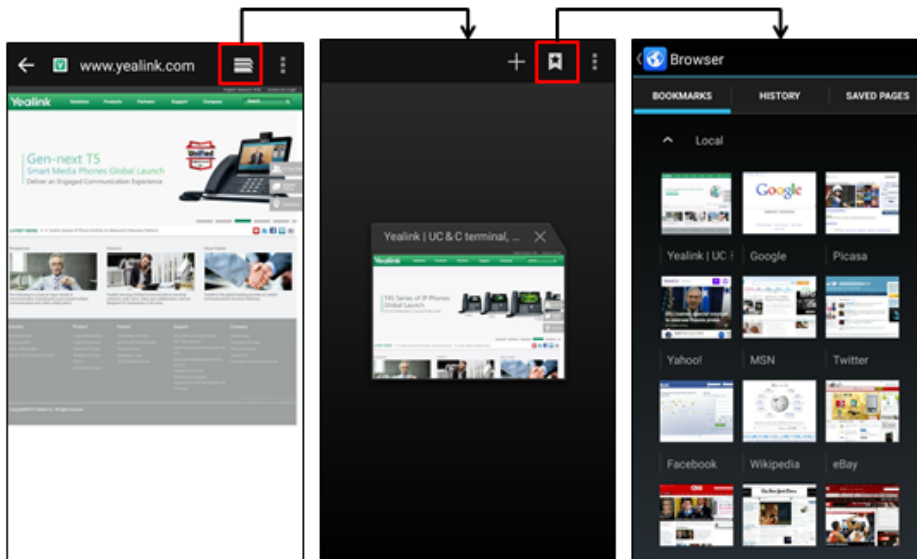



3. Tap the web page you want to visit.

Editing a Bookmark

You can edit the details of your bookmark for better recognition.

Procedure

1. Tap  to launch the **Browser**.
2. Tap  >  to access the **BOOKMARKS** list.
A list of web pages that you've bookmarked will appear.
3. Long tap the bookmark you want to edit.
4. Tap **Edit bookmark** in the pop-up dialog box.
5. Edit the bookmark.

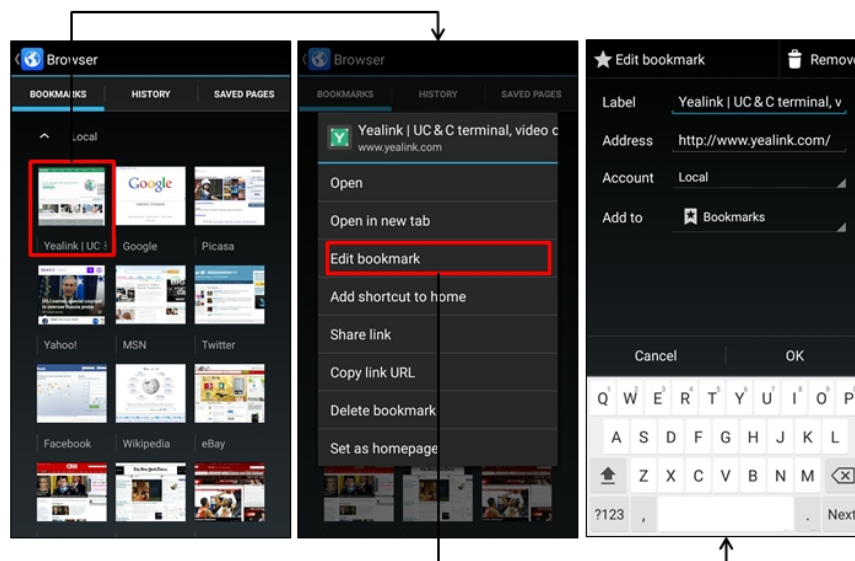



6. Tap **OK**.

Deleting a Bookmark

When you do not need the bookmark any more, you can delete it.



Procedure

1. Tap  to launch the **Browser**.
2. Tap  >  to access the **BOOKMARKS** list.
All pre-configured bookmarks are in the list.
3. Long tap the bookmark you want to delete.
4. Tap **Delete bookmark** in the pop-up dialog box.
5. Tap **OK**.

Setting a Home Page

You can set the web page you visit most frequently as the home page. This web page opens automatically each time you open the browser.

Procedure

1. Tap  to launch the **Browser**.
2. Tap  > **Settings** > **General** > **Set homepage**.
3. Tap the web page you want to set as the home page in the pop-up dialog box.



Tips

You can also long tap a web page in **BOOKMARKS** list and then tap **Set as homepage**.

Clearing the Navigation History

You can periodically clear your navigation history to protect your privacy and prevent information disclosure.



Procedure

1. Tap  to launch the **Browser**.
2. Navigate to  > **Settings** > **Privacy & security** > **Clear history**.
The phone screen prompts you whether to delete the browser navigation history.
3. Tap **OK**.

Modifying the Browser Settings

You can modify the browser settings to customize your **Browser**.



Procedure

1. Tap  to launch the **Browser**.
2. Tap  > **Settings**.
3. Customize the browser style you prefer.

Clock

You can use the **Clock** to check the time of other cities in the world.

Procedure

1. Tap the digital clock from the Home screen.
2. Tap .
3. Drag up and down to scroll through the cities.
4. Select the check box before the desired city.
5. Tap  to return to the clock screen.

The added clock of the desired city displays on the phone screen.

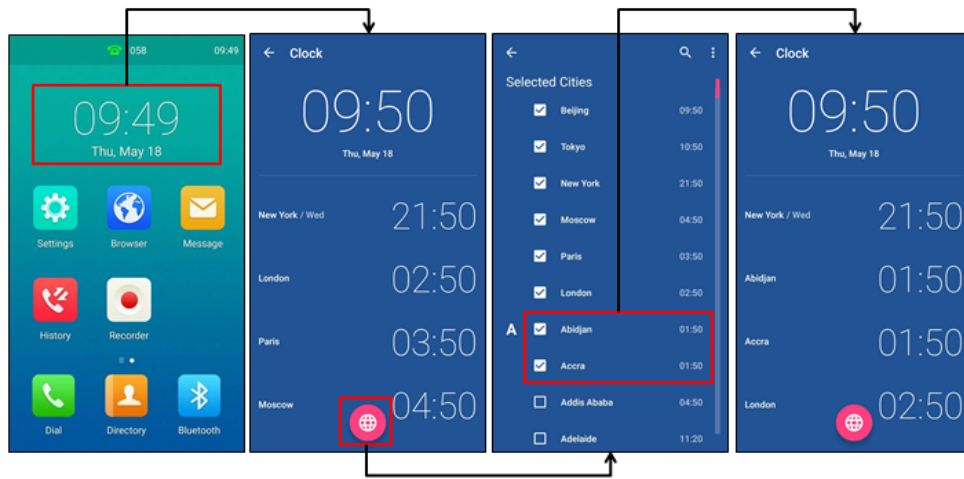

Customizing Your Phone

You can make your phone more personalized by customizing various settings.

Topics

[Changing the Administrator Password](#)
[Wallpaper](#)
[Screen Saver](#)
[Changing the Screen Backlight and Time](#)
[Changing the Language](#)
[Changing the Input Method](#)
[Time & Date](#)
[Phone Lock](#)
[Line Keys](#)

Changing the Administrator Password

By default, you require an administrator password to access the **Advanced/Advanced Settings** menu. The default password is "admin". For security reasons, you should change the default password as soon as possible.

Note

If you do not change the default password, the phone displays a warning icon in the status bar.

Procedure

1. Navigate to **Settings > Advanced Settings > Set Password**.
2. Enter your old and new password information.
3. Tap  .

Related Topic

[Investigating Warnings](#)

Wallpaper

You can change the background picture that is displayed on your phone.

The phone comes with a default background picture, you can change it to another built-in picture. You can also use a custom picture uploaded by your system administrator as the wallpaper.

Topic

[Changing Wallpaper on Idle Screen](#)

Changing Wallpaper on Idle Screen

You can set one of your pictures as the background image on your phone's idle screen.

Procedure

1. Navigate to **Settings > Basic Settings > Display > Wallpaper**.
2. Select the desired image.

3. Tap **Set wallpaper**.

Screen Saver

The screen saver starts automatically when your phone has been idle for the preset waiting time. You can stop the screen saver by touching the screen or tapping any key.

Topics

[Changing the Waiting Time for Screen Saver](#)

[Setting the Screen Saver Type](#)

Changing the Waiting Time for Screen Saver

You can set the waiting time after no activity before displaying the screen saver.

Procedure

1. Navigate to **Settings > Basic Settings > Display > Screen Saver**.
2. Select the desired waiting time from the **Screensaver Waiting Time** field.
3. Tap  .

Setting the Screen Saver Type

The screen saver can start with different types and you can set it manually.

Your phone supports four screen saver types: **Clock**, **Colours**, **Photo Frame** and **Photo Table**.

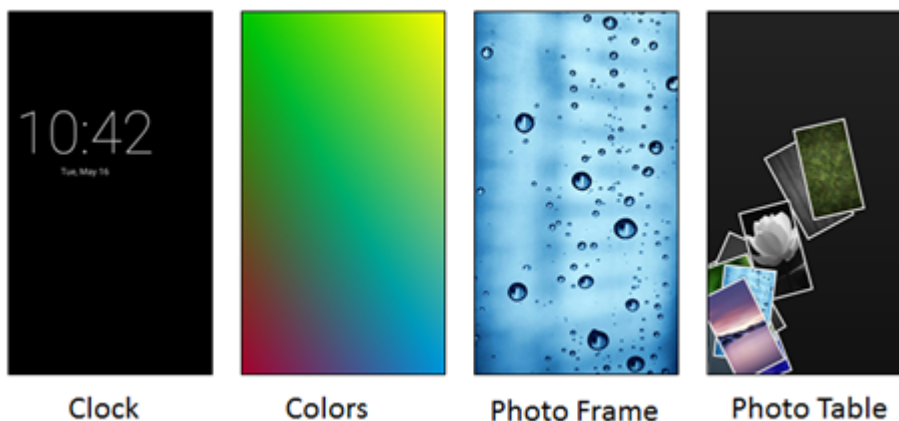

Procedure

1. Navigate to **Settings > Basic Settings > Display > Screen Saver**.
2. Tap  .

Changing the Screen Backlight and Time

You can change the brightness of the phone screen during phone activity and inactivity.

Active Level: The intensity of the phone screen when the phone is active.

Backlight Time: The delay time to change the brightness of the phone screen when the phone is inactive. Backlight time includes the following settings:

- **Always On:** Backlight is on permanently.
- **15s, 30s, 1min, 2min, 5min, 10min or 30min:** Backlight is changed when the phone is inactive after the designated time.

Procedure

1. Swipe down from the top of the screen.
2. Do one of the following:
 - Drag the backlight slider.

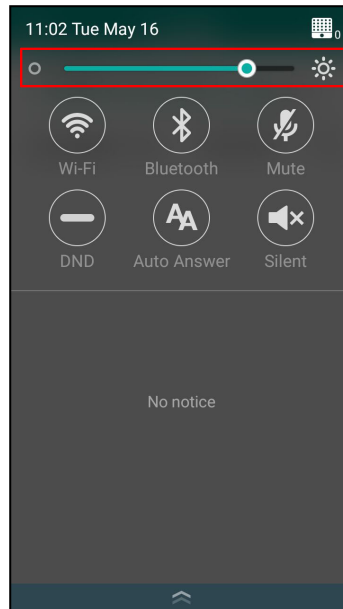

When dragging the slider, the control center (except the backlight slider) and notification center will be hidden. You can view the intensity changes of the phone screen in real-time.

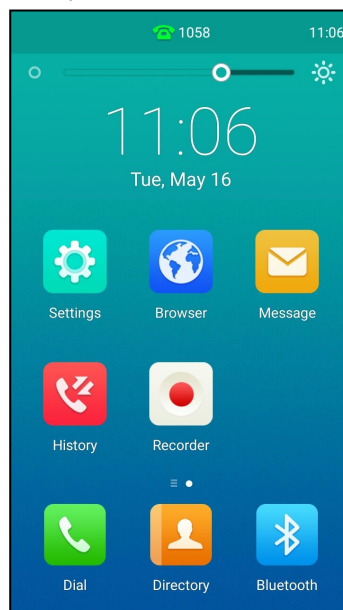

If you lift your finger, the control center and notification center will be shown again.

- Tap .

The intensity of the phone screen is changed to the highest.

- Tap .

The intensity of the phone screen is changed to the lowest.

Tips

You can only change the screen intensity during phone activity on the control center. To change the backlight time, navigate to **Settings > Basic Settings > Display > Backlight**.

Changing the Language

Your phone supports several languages that you can choose to use on the phone.

Contact your system administrator to find out exactly which languages are supported on your phone.

Procedure

1. Navigate to **Settings > Basic Settings > Language & Input > Language**.
2. Select the desired language.
3. Tap .

The phone language is changed to the selected one.

Changing the Input Method

The phone supports two kinds of input methods: English (UK) and 谷歌拼音输入法. The default input method is English (UK). You can change the currently used input method.

Procedure

1. Navigate to **Settings > Basic Settings > Language & Input > Current Input**.
2. Select the desired input method.

You can also long tap the space key on the onscreen keyboard to change the input method.

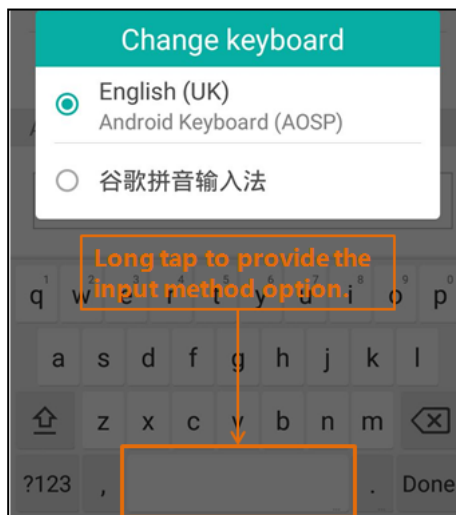

Time & Date

You can set the time and date manually. The time and date formats are also variable.

Topics

[Setting the Time and Date Manually](#)

[Changing the Time and Date Format](#)

Setting the Time and Date Manually

If your phone cannot obtain the time and date automatically, you can set it manually.

Procedure

1. Navigate to **Settings > Basic Settings > Time & Date > General**.
2. Edit the date and time.
3. Tap  .

The time and date set on the phone will be changed accordingly.

Changing the Time and Date Format

You can set the phone to display the time in 12-hour format or 24-hour format. You can also change the date format, including the options to display the day (D), month (M), and year (Y).

Note

Your system administrator can customize the date format.

Procedure

1. Navigate to **Settings > Basic Settings > Time & Date > Time & Date Format**.
2. Select the desired time format or date format.
3. Tap  .

Phone Lock

Phone lock helps you protect your phone from unauthorized use.

Topics

[Setting the Phone Lock](#)

[Setting a Phone Lock Key](#)

[Locking Your Phone Manually](#)

[Unlocking Your Phone](#)

[Changing Your Phone Unlock PIN](#)

Setting the Phone Lock

You can manually lock the phone or wait a specified time to automatically lock the phone.

When your phone is locked, you can:

- Dial emergency numbers.
- Reject incoming calls.
- Answer incoming calls.
- End the call.

Procedure

1. Navigate to **Settings** > **Advanced Settings** (default password: admin) > **Phone Lock**.
2. Select **Enabled** from the **Lock Enable** field.
3. Enter the desired interval (0 - 3600 seconds) in the **Auto Lock** field.
4. Tap .

Note

Ask your system administrator for the password if you cannot access Advanced Settings menu.

Setting a Phone Lock Key

You have to set a phone lock key manually to lock your phone.

Procedure

1. Navigate to **Settings** > **Features** > **Dsskey**.
2. Select the desired line key.
3. Select **Key Event** from the **Type** field.
4. Select **Phone Lock** from the **Key Type** field.
5. (Optional.) Enter the string that will display on the phone screen in the **Label** field.
6. Tap .

Locking Your Phone Manually

You can lock the phone manually before the phone is automatically locked.

Before You Begin

Make sure that the phone lock is set and you have set a phone lock key.

Procedure

1. Tap the phone lock key.

The lock icon appears on the phone screen.

Related Topics

[Setting the Phone Lock](#)

[Setting a Phone Lock Key](#)

Unlocking Your Phone

You can use an unlock PIN to unlock the phone.

If you forget the unlock PIN, you can enter the administrator password to unlock your phone, and then automatically access the PIN change screen.

Procedure

1. Tap the screen or tap the Mute touch key, the phone prompts you to enter an unlock PIN.
2. Enter the desired PIN (default: 123) in the **Unlock PIN** field.
3. Select **OK**.

The lock icon disappears from the phone screen.

Changing Your Phone Unlock PIN

The default unlock PIN is "123". For security reasons, you should change the default unlock PIN as soon as possible.

Procedure

1. Navigate to **Settings > Basic Settings > Change PIN.**
2. Enter your old and new unlock PIN respectively.
The unlock PIN length must be within 15 digits.
3. Tap ✓ .

Line Keys

Line keys allow you to quickly access features such as recall and speed dial. The line key can indicate the monitored status when the line keys are assigned with particular features, such as BLF.

You can assign predefined functions to line keys. You can also define a label for a line key feature which will appear on the phone screen.

Topics

[Assigning Functionality to a Line Key](#)

[Changing the Locations of the Line Keys](#)

[Deleting a Line Key](#)

Assigning Functionality to a Line Key

You can assign functions to a line key, as a result, you can access this function quickly by tapping this line key.

Procedure

1. Do one of the following:
 - Tap + on the top-right of the line key list.

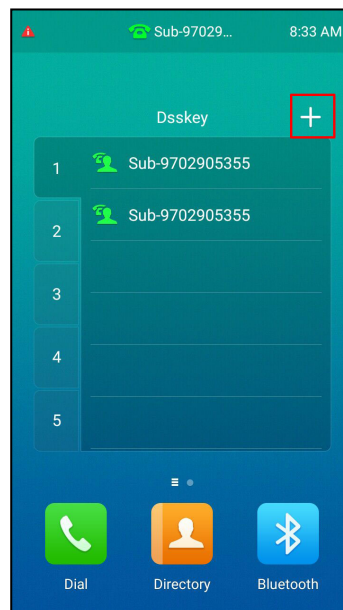

- Navigate to **Settings > Features > Dsskey.**
Tap the desired line key.
2. Select the desired key type from the **Type** field.
 3. Configure the settings for the corresponding key type.

4. Tap ✓.

Changing the Locations of the Line Keys

You can change the order in which your line keys display on the phone screen.

Procedure

1. Tap the desired page key if required.
2. Drag a line key to the desired location at which another line key locates.

For example, exchange the locations of line key 1 and line key 2:

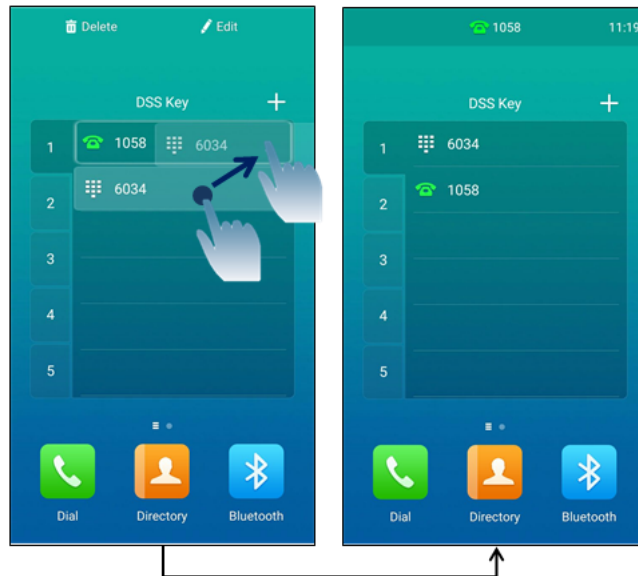

Deleting a Line Key

You can delete a line key when you no longer need the corresponding function.

Procedure

1. Drag the desired line key to the **Delete** field.



The phone prompts you whether to delete the DSS key.

2. Tap **OK**.

Audio Settings

You can change the basic audio settings on your phone.

Topics

[Adjusting the Volume](#)

[Setting the Ring Tone](#)

[Disabling the Key Tone](#)

[Enabling Touch Tone](#)

[Configuring Notification Sound](#)

[Enabling Silent Mode](#)

Adjusting the Volume

You can adjust the volume of ringer, media, and the audio during a call.

Procedure

1. Tap the Volume touch key to adjust the volume.

Setting the Ring Tone

You can set distinctive ring tones for groups or contacts in your Local Directory, so that you can identify the caller when your phone rings.

The ring tones are used according to this priority: Contact ring tone>Group ring tone>Account ring tone >Phone ring tone.

Topics

[Setting a Ring Tone for the Phone](#)

[Setting a Ring Tone for an Account](#)

[Setting a Ring Tone for a Group](#)

[Setting a Ring Tone for a Contact](#)

Setting a Ring Tone for the Phone

You can choose a ring tone for all incoming calls.

Procedure

1. Navigate to **Settings > Basic Settings > Sound > Ring Tones > Common**.
2. Select the desired ring tone.
3. Tap  .

Setting a Ring Tone for an Account

You can select a unique ring tone for an individual account.

Procedure

1. Navigate to **Settings > Basic Settings > Sound > Ring Tones**.
2. Select the desired account.
3. Select the desired ring tone.

If **Common** is selected, this account will use the ring tone selected for the phone.

4. Tap  .



Setting a Ring Tone for a Group

You can select a unique ring tone for various groups in your Local Directory.

Note

You can only set a ring tone for a group that is added manually.

Procedure

1. Tap  > **Local Directory**.
2. Tap  after the desired group, and then tap **Ring**.
3. Select the desired ring tone.

If **Auto** is selected, this group uses the ring tone according to the default priority.



If a specific ring tone is selected, this group uses the ring tone according to the priority: Contact ring tone>Group ring tone.

4. Tap **OK**.

Setting a Ring Tone for a Contact

You can select a unique ring tone for various contacts in your Local Directory. This helps you quickly identify callers according to the ring tones.

Procedure

1. Tap  .
2. Tap **Local Directory** to select the desired contact group.
3. Tap  after the desired contact.
4. Select the desired ring tone from the **Ring** field.

*If **Auto** is selected, the contact uses the ring tone according to the default priority.*

5. Tap  .

Disabling the Key Tone

If you disable the key tone, the phone will not produce a sound when tapping the keypad keys.

Procedure

1. Navigate to **Settings** > **Basic Settings** > **Sound** > **Key Tone**.
2. Turn off **Key Tone**.
3. Tap  .

Enabling Touch Tone

If you enable touch tone, the phone will produce a sound when you tap an option on the phone screen.

Procedure

1. Navigate to **Settings > Basic Settings > Sound > Touch Tone**.
2. Turn on **Touch Tone**.
3. Tap  .

Configuring Notification Sound

The phone will produce a notification sound when receiving a notification (for example, incoming email notification).

Procedure

1. Navigate to **Settings > Basic Settings > Sound**.
2. Tap the desired notification sound from the **Notification Sound** field.
3. Tap **OK**.

Enabling Silent Mode

If you turn on the silent mode, your phone won't produce a ring tone/key tone/touch sound/notification sound from phone's speaker.

Procedure

1. Do one of the following:
 - Navigate to **Settings > Basic Settings > Sound**.
Turn on **Silent Mode** and then tap  .
 - Long tap the left Volume touch key to decrease the ringer volume to the minimum.
 - Swipe down from the top of the screen and toggle **Silent** on.

Note

You may have no permission to turn on the silent mode. Contact your system administrator for more information.

Using Your Phone with PC

When connected to the PC, the phone acts as a speaker and microphone during calls.

From your phone, you can do the following:

- Manage the audio from calls or media played on your PC.
- Merge phone calls, the PC and connected mobile phone into a hybrid UC conference. For more information, refer to [Creating a Hybrid UC Conference](#).
- Answer calls from the softphone.

Tips

You can install a softphone (e.g., Yealink VC Desktop) on PC to make calls.

Topics

[Connecting the PC to the Phone](#)

[Setting the Phone as PC Audio Device](#)

[Holding/Resuming the PC Audio](#)

[Muting or Unmuting the Microphone](#)

Connecting the PC to the Phone

You can connect the PC to the phone for playing the PC audio.

Procedure

1. Connect the phone to a PC using a micro USB cable.
 - When your phone is idle, the phone screen is shown as below:

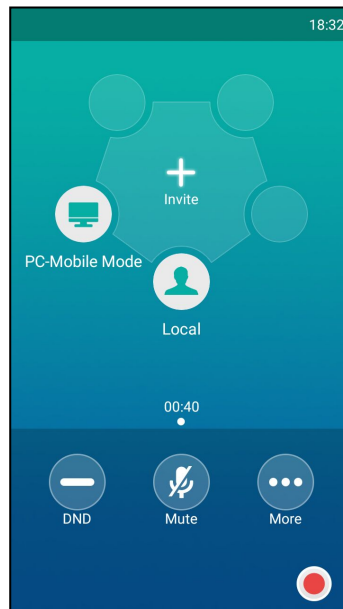

- When there is a call or conference call on your phone, the original call or conference call is placed on hold.

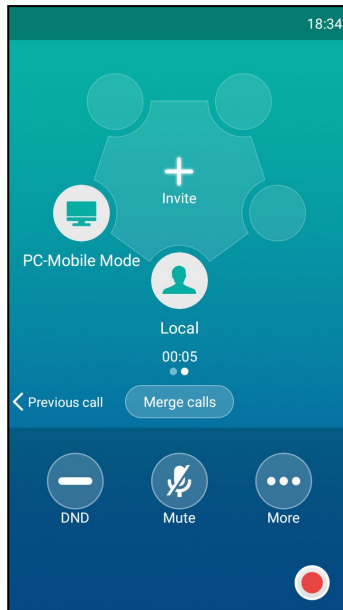

- When you are placing a call, the dialing is cancelled.

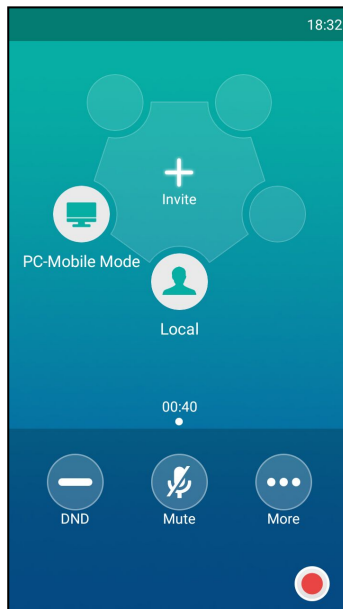

Setting the Phone as PC Audio Device

By default, the PC automatically selects the connected phone as the audio device. If not, you may have to set the phone as PC audio device via softphone or PC.

Topics

[Setting the Phone as PC Audio Device via Softphone](#)

[Setting the Phone as PC Audio Device via PC](#)

Setting the Phone as PC Audio Device via Softphone

When your PC is connected to the phone, you can set the phone as PC audio input and output device via the softphone, for example, Yealink VC Desktop.

Procedure

1. In the top-left corner of the window, click the avatar icon to enter the settings window.
2. Click **Device**.
3. Select your phone from the drop-down menu of **Speaker**.
4. Select your phone from the drop-down menu of **Microphone**.
5. (Optional) Click **Test** to test the microphone or the speaker.

Setting the Phone as PC Audio Device via PC

When your PC is connected to the phone, you can set the phone as the PC default audio device via PC.

Procedure

1. Click **Start > Control Panel > Sound**.
2. Click **Echo Cancelling Speakerphone** and click **Set as Default Device**.
3. Click **Microphone** and click **Set as Default Device**.
4. Click **OK**.

Holding/Resuming the PC Audio

When you place the PC audio on hold, you cannot hear any audio on your phone.

Procedure

1. Tap **More > Hold**.
2. Tap **More > Resume** or tap **Resume** to resume the PC audio.

Muting or Unmuting the Microphone

When you mute the microphone during a call, the other party cannot hear you but you can hear other parties.

Procedure

1. Tap **Mute** or the Mute touch key.
The mute touch key LED indicators glow red. The phone screen indicates that the audio is muted.
2. Tap **Mute** or the Mute touch key again to unmute the microphone.

Using the CP Wireless Expansion Mic CPW90

The Yealink CPW90 is a CP Wireless Expansion Mic which works as an audio input device for CP960 phone. It features superior audio technology and supports 360-degree voice pickup range at a radius of up to 10 feet (3 meters) without any wiring troubles.

Topics

- [Placing the CPW90](#)
- [Turning the CPW90 On or Off](#)
- [Registering the CPW90](#)
- [Registering the CPW90 with another Phone](#)
- [Unregistering the CPW90](#)
- [Muting or Unmuting the CPW90](#)
- [Idle Mode](#)
- [Viewing CPW90 Information](#)
- [Finding the CPW90](#)
- [Charging the CPW90](#)
- [CPW90 LED Instructions](#)
- [CPW90 Working Frequency](#)

Placing the CPW90

The CPW90 has rubber pads on its base to prevent it from sliding. You can place the CPW90 on a conference table.

Do the following to ensure optimal voice quality:

- The CPW90 should be less than 20 meters distant from the IP phones, and is not disturbed by obstacles.
- Place the CPW90 on a stable surface and keep it away from obstacles so that it can effectively pick up sounds.

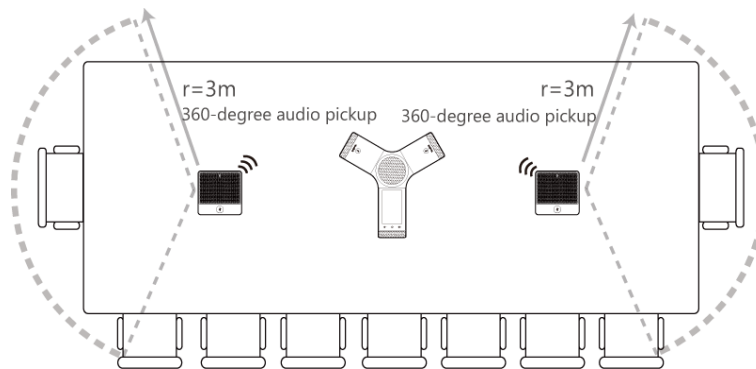

Turning the CPW90 On or Off

To use the CPW90 as the external audio input device, you need to turn the CPW90 on first.

Procedure

1. You can do the following to turn on the CPW90:
 - Put the CPW90 on a charging cradle, the CPW90 starts up automatically.
 - If you do not charge the CPW90, long tap  on the CPW90 for 3 seconds.

The battery LED indicator glows solid green for one second and then goes out.

2. To turn off the CPW90, long tap  on the CPW90 until the battery LED indicator on the CPW90 glows solid red for 3 seconds and then goes out.

Registering the CPW90

To ensure good voice quality of the calls on the IP phones, you can register CPW90 with the phone to use the CPW90 as the external audio input device.

Note

If you buy CP960-WirelessMic, the CPW90 is registered with the phone by default.

Procedure

1. Navigate to **Settings** > **Basic Settings** > **Wireless Microphone**.
2. Tap  to search for CPW90.

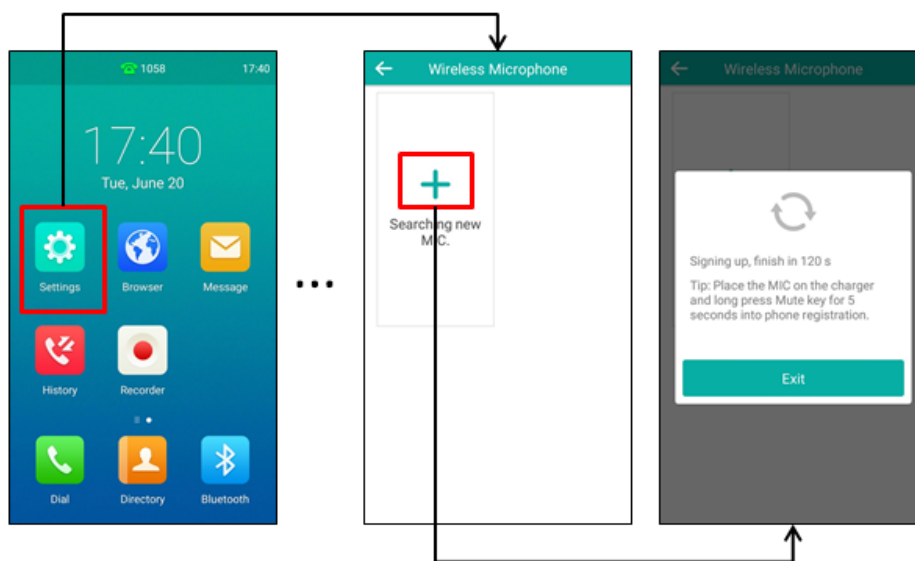

3. Turn on the CPW90.

The CPW90 will enter the registration mode automatically. And the mute LED indicator on the CPW90 fast flashes yellow.

The CPW90 registers with the phone automatically. If the registration is successful, the mute LED indicator on the CPW90 goes out and phone screen prompts the CPW90 information: battery, work time and standby time.

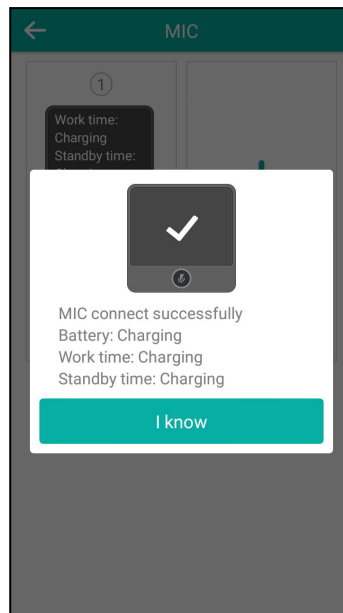

Registering the CPW90 with another Phone

When you no longer want to register with the current phone, you can register the CPW90 with another phone.

CPW90 can only be registered with one phone at a time, if you register the CPW90 to another IP phones, the CPW90 will deregister from the previous phone automatically.

Procedure

1. Navigate to **Settings > Basic Settings > Wireless Microphone**.
2. Tap **+** to search for CPW90.
3. Put the CPW90 on the charging cradle and make sure it is charging.
4. Long tap the Mute key on the CPW90 for 5 seconds.

The CPW90 enters the registration mode. And the mute LED indicator on the CPW90 fast flashes yellow.

The CPW90 registers with the phone automatically.

Unregistering the CPW90

When you no longer need the CPW90 as the external audio input device, you can unregister it.

Procedure

1. Navigate to **Settings > Basic Settings > Wireless Microphone**.
2. Select the desired microphone and then tap **Detail**.
3. Tap **Unbind** to deregister the CPW90.

Muting or Unmuting the CPW90

During the call, you can mute or unmute the CPW90 at any time.

Procedure

1. Tap the Mute key to mute the call.

The mute LED indicator glows solid red. And the icon  appears on the status bar of the phone.

2. Tap the Mute key again to unmute the call.

The mute LED indicator glows solid green. And the icon  disappears from the status bar of the phone.

Idle Mode

When the CPW90 registers with the phone successfully, the CPW90 enters the idle mode. You can tap the Mute key on the CPW90, the battery LED indicator on the CPW90 glows solid green for 3 seconds and then goes out.

Viewing CPW90 Information

When the CPW90 is registered with the IP phones, you can view CPW90 status on the phone.

Available information of CPW90 includes:

- Register Status
- Mic Model
- MICPOD IPEI
- Battery Percent
- Standby Time (estimated standby time)
- Work Time(estimated working time)

Procedure

1. Navigate to **Settings > Basic Settings > Wireless Microphone**.
2. Tap **Detail** from the desired microphone block.

Finding the CPW90

You can find the CPW90 which has registered with the phone.

Procedure

1. Navigate to **Settings > Basic Settings > Wireless Microphone**.
2. Tap **Find** from the desired microphone block.

The mute key LED indicator on the registered CPW90 flashes red and green alternately.

Charging the CPW90

The phone can power to the USB port, so you can directly charge the CPW90 on the phone.

If it is the first time you use the CPW90, you need to fully charge the CPW90 for normal use. If the CPW90 is not in use, we recommend you to charge the CPW90 even when the battery is full.

Procedure

1. Put the CPW90 on the charging cradle.
2. Connect the micro USB port on the charging cradle to the USB port on the phone using a 0.3m micro USB cable.

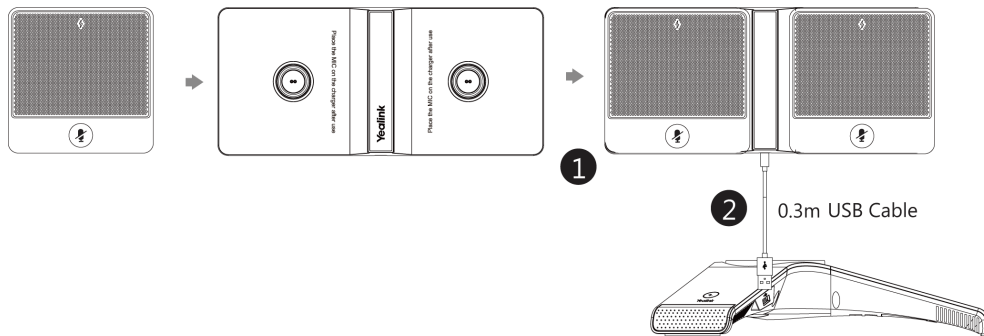

During charging, the battery LED indicator on the CPW90 glows solid red. When the battery capacity reaches 100%, the battery LED indicator on the CPW90 will glow solid green.

Note

If your system administrator disables the USB port of the phone, the phone cannot power to the USB port.

CPW90 LED Instructions

The CP930W LED indicator indicates the call, register and battery's system status.

Mute button indicator LED on the wireless expansion microphone CPW90:

LED Status	Description
Solid green	The phone enters the pre-dialing screen. The phone is in a call and unmuted.
Slowly flashing red	The phone is receiving an incoming call.
Solid red	The phone is muted.
Fast flashing yellow	The CPW90 is in the registration mode.
Slowly flashing yellow	The CPW90 has registered with the phone, but the CPW90 is out of range. The CPW90 has registered with the phone, but the CP960 is turned off.
Flashing red and green alternately	The phone is searching for the CPW90 which has registered with it.
Off	The CPW90 is in the idle mode.

Battery indicator LED on the wireless expansion microphone CPW90:

LED Status	Description
Solid green for one second and then off	The CPW90 is turned on.
Solid green for 3 seconds and then off	The CPW90 is in the idle mode.
Solid green	The CPW90 is fully charged.
Solid red	The CPW90 is being charged.
Fast flashing red 3 times and then off	The battery capacity is too low to turn on the CPW90.
Slowly flashing red	The battery capacity is less than 10%.

LED Status	Description
Off	If you tap the mute button, the battery indicator LED on the CPW90 is still off, it means the CPW90 is turned off.

CPW90 Working Frequency

You need to understand the Frequency/Channels of CPW90 for its better performance.

For reference, the Frequency/Channels of CPW90 used in each Region are tabulated below:

Freq (MHz)	RF Carrier Index (DECT tester Numbering)						
	EU	Taiwan	US	LA	Korea	Brazil	Japan
1881.792	9	9					
1883.520	8	8					
1885.248	7	7					
1886.976	6	6					
1888.704	5	5					
1890.432	4	4					
1892.160	3	3					
1893.888	2	2					
1895.616	1						4(F1)
1897.344	0						3(F2)
1899.072							2(F3)
1900.800							1(F4)
1902.528							0(F5)
1904.256							
1905.984							
1907.712							
1909.440							
1911.168						4	
1912.896				9		3	
1914.624				8		2	
1916.352				7		1	
1918.080				6		0	

Freq (MHz)	RF Carrier Index (DECT tester Numbering)						
	1919.4 808				5		
1921.536			4	4			
1923.264			3	3			
1924.992			2	2			
1926.720			1	1			
1928.448			0	0			
1787.616					8		
1789.344					7		
1791.072					6		

Using CP960 Star Connection Feature

You can deploy up to four CP960 phones in a star layout. In the star connection group, one phone acts as a master phone, while other phones act as the slave phones.

The master phone keeps all features, while the slave phones only sync some key features of the master phone, such as DND and call mute. After connecting, the slave phones are mainly used to work as speakers or microphones.

Before You Begin

Make sure all the phones are deployed in the same subnet. And all the phones are running the same firmware versions. You cannot activate Wi-Fi when using star connection feature.

Topics





[State Indicator of CP960 Star Connection](#)

[Configuring the Master Phone](#)

[Configuring the Slave Phone](#)

State Indicator of CP960 Star Connection

The state indicator indicates the current status of the CP960 star connection.

Icons	Description
	The slave phone is disconnected from the master phone.
	The star connection group is set up, but there are no slave phones in the star connection group.
	The number of the slave phones connected successfully is less than the maximum number of slave phones in a star connection group. "n" indicates the number of connected slave phones.
	All the slave phones in the star connection group are connected successfully. "n" indicates the number of connected slave phones.

Configuring the Master Phone

You can set up a star connection group, remove any slave phone, and dissolve a star connection group. You can also quickly find a slave phone.

Topics

[Setting Up a Star Connection Group](#)

[Sending Broadcast from Master Phone](#)

[Removing a Slave Phone](#)

[Dissolving a Star Connection Group](#)

[Finding a Slave Phone](#)

[Stop Finding a Slave Phone](#)

Setting Up a Star Connection Group

If your system administrator has not specified your phone as a master phone, you need to manually create a star connection group on your phone.

Procedure

1. Navigate to **Settings > Advanced Settings** (default password: admin) > **CP Star Connection > Create Group**.

The phone automatically generates a four-digit PIN number and sends the broadcast.

After the slave phones join the star connection group, a star connection icon appears in the status bar.

Related Topic

[Sending Broadcast from Master Phone](#)

Sending Broadcast from Master Phone

You can make the master phone send broadcast for waiting for other slave phones to join the star connection group.

Procedure

1. Navigate to **Settings > Advanced Settings** (default password: admin) > **CP Star Connection > Start Broadcast**.

The phone automatically generates a four-digit PIN number and sends the broadcast.

Related Topic

[Setting Up a Star Connection Group](#)

Removing a Slave Phone

You can remove a slave phone from the star connection group.

Procedure

1. Navigate to **Settings > Advanced Settings** (default password: admin) > **CP Star Connection**.
2. Select the desired slave phone.
3. Tap **Remove**.

The phone prompts you whether to remove the slave phone.

4. Tap **OK**.

The slave phone is removed from the star connection group successfully.

Dissolving a Star Connection Group

You can dissolve a star connection group when the phone no longer needs the connection.

Procedure

1. Navigate to **Settings > Advanced Settings** (default password: admin) > **CP Star Connection**.
2. Tap the master phone icon.
3. Tap **Dissolve Group**.

The phone prompts you whether to dissolve the star connection group.

4. Tap **OK**.

The phone dissolves the star connection group successfully.

Finding a Slave Phone

You can find which slave phones join the star connection group on the master phone.

Procedure

1. Navigate to **Settings > Advanced Settings** (default password: admin) > **CP Star Connection**.
2. Tap the desired slave phone.
3. Tap **Find**.

The master phone will automatically find the slave phone in your area.

The slave phone will play the ring tone, and the mute key LED indicators on the phone flash green and red alternately.

Related Topics

[Setting Up a Star Connection Group](#)

[Joining a Star Connection Group](#)

[Stop Finding a Slave Phone](#)

Stop Finding a Slave Phone

If you find your slave phone, you can manually stop finding the slave phone on the master phone.

Procedure

1. Tap **Exit** on the master phone.

The slave phone will stop ringing.

Tips

You can also stop finding a slave phone by tapping any touch key on the slave phone.

Configuring the Slave Phone

You can join a star connection group and quit the star connection group on the slave phone. You can also quickly find a master phone.

Topics

[Joining a Star Connection Group](#)

[Quitting a Star Connection Group](#)

[Finding a Master Phone](#)

[Stop Finding a Master Phone](#)

Joining a Star Connection Group

You can join your phone to a star connection group as a slave phone.

Before You Begin

The master phone has set up a star connection group and is in broadcast status.

Procedure

1. Navigate to **Settings > Advanced Settings** (default password: admin) > **CP Star Connection > Search Group**.

The phone will automatically search for broadcasts sent by the master phone in your area.

2. Tap **Join**.

3. Enter the PIN number displayed on the master phone.

After reboot, the phone joins the star connection group successfully.

The star connection name (for example, CP960-S1) is displayed on the idle screen, and a star connection icon appears in the status bar.

Note

One CP960 phone can only join one star connection group.

Related Topics

[Setting Up a Star Connection Group](#)
[Sending Broadcast from Master Phone](#)

Quitting a Star Connection Group

When you need use your phone as a normal conference phone, you can quit a star connection group.

Procedure

1. Navigate to **Settings** > **Advanced Settings** (default password: admin) > **CP Star Connection**.
2. Tap the desired slave phone.
3. Tap **Quite Group**.

The phone prompts you whether to quit the star connection group.

4. Tap **OK**.

After reboot, the phone quits the star connection group successfully.

Finding a Master Phone

You can confirm the actual location of the master phone on any slave phone.

Procedure

1. Tap **Find master**.

The slave phone will automatically find the master phone in your area.

The master phone will play the ring tone, and the mute key LED indicators on the phone flash green and red alternately.

Related Topics

[Joining a Star Connection Group](#)
[Stop Finding a Master Phone](#)

Stop Finding a Master Phone

If you find your master phone, you can manually stop finding at any time.

Procedure

1. Tap **Exit** on the slave phone.

The master phone will stop ringing.

Tips

You can also stop finding a master phone by tapping any touch key on the master phone.

Connecting a Mobile Phone Using Bluetooth

Bluetooth enables low-bandwidth wireless connections within a range of 10 meters (32 feet). The best performance is in the 1 to 2 meters (3 to 6 feet) range.

You can pair and connect the Bluetooth-enabled mobile phone with your phone. After connection, you can do the following:

- Make and receive mobile calls on the phone
- Use the phone as a Bluetooth speaker for music played on your mobile phone.
- Merge the calls on your phone, the PC and connected mobile phone into a hybrid UC conference (refer to [Creating a Hybrid UC Conference](#)).

Note

Not all mobile phones support this feature. Contact your system administrator for more information.

Tips

You can also connect a PC (operation system: macOS and Window10) via Bluetooth. After connection, you can place/answer a call via a softphone installed on PC using the phone.

Topics

- [Activating the Bluetooth Mode](#)
- [Pairing and Connecting the Bluetooth-enabled Mobile Phone](#)
- [Configuring the Phone Audio Feature](#)
- [Handling a Mobile Phone Call on the Phone](#)
- [Configuring the Media Audio Feature](#)
- [Renaming the Paired Bluetooth-enabled Mobile Phone](#)
- [Disabling Bluetooth Device Discovery](#)
- [Changing Your Phone's Bluetooth Name](#)
- [Unpairing the Mobile Phone](#)
- [Disconnecting the Bluetooth-enabled Mobile Phone](#)
- [Deactivating the Bluetooth Mode](#)

Activating the Bluetooth Mode

You should activate the Bluetooth mode first when you need to connect the Bluetooth device to your phone.

Procedure

1. Do one of the following:
 - Swipe down from the top of the screen.
 - Tap .
 - Navigate to **Settings** > **Basic Settings** > **Bluetooth**.
2. Turn on the Bluetooth.

The phone automatically scans the available Bluetooth devices in your area.

The Bluetooth icon appears in the status bar.

Pairing and Connecting the Bluetooth-enabled Mobile Phone

You can pair up with countless mobile phones with your phone but only one mobile phone can be connected at a time.

After connection, the phone will automatically find an available line key and assign the line key for Mobile Account. The Mobile Account key's default label is "My Mobile". If there is no available line key, you can assign it manually.

Before You Begin

Make sure that the Bluetooth-enabled mobile phone is discoverable.

Procedure

1. Navigate to **Settings** > **Basic Settings** > **Bluetooth**.
2. Tap  to search for the mobile phone.
3. Tap the desired Bluetooth-enabled mobile phone.
4. Tap **Pair** on both mobile phone and phone.

The connection will be completed successfully with a prompt appears under the Bluetooth-enabled mobile phone name.

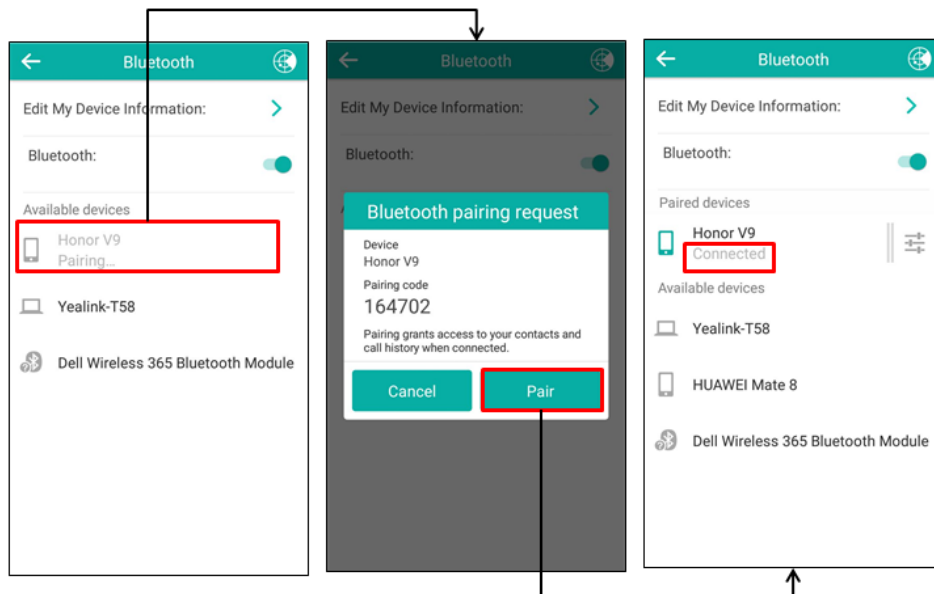

And the phone automatically assigns a Mobile Account key.

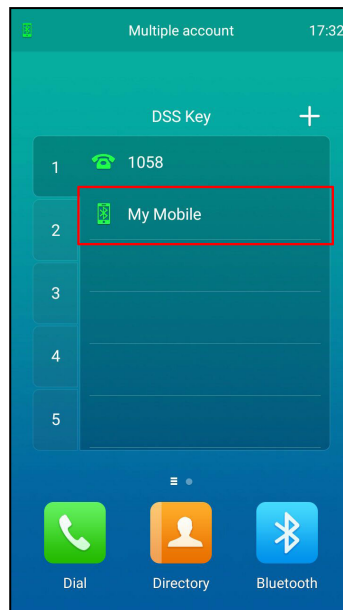



Related Topic

[Activating the Bluetooth Mode](#)

Configuring the Phone Audio Feature

After connecting your Bluetooth-enabled mobile phone, the phone acts as a hands-free device for your mobile phone. The call is made through your mobile phone, but the audio is present and the call control is done by the phone.

Procedure

1. Navigate to **Settings** > **Basic Settings** > **Bluetooth**.
2. Tap  after the desired Bluetooth-enabled mobile phone name.
3. Turn on **Phone audio**.
4. Tap .

Related Topics



[Pairing and Connecting the Bluetooth-enabled Mobile Phone](#)

[Handling a Mobile Phone Call on the Phone](#)

Configuring the Media Audio Feature

After connecting your Bluetooth-enabled mobile phone, you can enable the media audio feature to stream Bluetooth-enabled mobile phone audio to SIP phone. Then the SIP phone acts as the Bluetooth-enabled mobile phone player.

Procedure

1. Navigate to **Settings** > **Basic Settings** > **Bluetooth**.
2. Tap  after the connected Bluetooth-enabled mobile phone name.
3. Turn on **Media audio**.
4. Tap .

Related Topic

[Pairing and Connecting the Bluetooth-enabled Mobile Phone](#)

Handling a Mobile Phone Call on the Phone

You can handle a mobile phone call on your phone, the phone acts as a hands-free device for your mobile phone.

The call information appears on both your phone and mobile phone screen. You can control the call's audio to go through the mobile phone or phone on your mobile phone. If you choose Bluetooth, the audio will go through the phone; if you choose Handset earpiece or Speaker, the audio will go through the mobile phone.

Before You Begin

Make sure that the Bluetooth-enabled mobile phone is paired and connected to your phone, and the phone audio feature is enabled.

Procedure

1. Do the following on the phone:
 - Place a call. Tap the **My Mobile** line key first, and then place a call or multiple calls to the mobile contacts.
 - Answer a call. An incoming call to your mobile phone is also shown on the phones, you can answer the call on the phone. The phone will firstly match the contacts in the mobile contacts directory to present the caller identity.
 - During the call, you can hold/resume, mute/unmute or end the call on the phone.

Related Topics



[Pairing and Connecting the Bluetooth-enabled Mobile Phone](#)

[Configuring the Phone Audio Feature](#)

Renaming the Paired Bluetooth-enabled Mobile Phone

You can rename the paired Bluetooth-enabled mobile phone, so that you can easily recognize it.

Procedure

1. Navigate to **Settings > Basic Settings > Bluetooth**.
2. Tap  after the connected mobile phone name.
3. Enter the desired device name in the **Rename** field.
4. Tap .

*The configured mobile phone name will display in the **Paired devices** list on your phone. The mobile phone name displayed in the scanning list of other devices will not be changed.*

Related Topic

[Pairing and Connecting the Bluetooth-enabled Mobile Phone](#)

Disabling Bluetooth Device Discovery

After the Bluetooth is activated, the phone is automatically placed in Open Discover mode to make it visible to other Bluetooth devices.

You can choose to disable this feature to not allow your phone to show as an available device on other Bluetooth devices.

Procedure

1. Navigate to **Settings** > **Basic Settings** > **Bluetooth** > **Edit My Device Information**.
2. Turn on **Open Discover**.
3. Tap .

Related Topic

[Activating the Bluetooth Mode](#)

Changing Your Phone's Bluetooth Name

You can change the Bluetooth name for your phone to identify your phone to other Bluetooth devices.

By default, the phone is identified as Yealink-CP960 by other Bluetooth devices.

Before You Begin

Make sure that the Bluetooth mode is activated.

Procedure

1. Navigate to **Setting** > **Basic Settings** > **Bluetooth** > **Edit My Device Information**.
2. Enter the desired name in the **Device Name** field.
3. Tap .

Related Topics



[Activating the Bluetooth Mode](#)

[Disabling Bluetooth Device Discovery](#)

Unpairing the Mobile Phone

When you unpair the mobile phone, the mobile phone information disappears from the **Paired devices** list. To connect the mobile phone to your phone again, tap the desired mobile phone in the **Available devices** list.

Procedure

1. Do one of the following:
 - Tap .
 - Swipe down from the top of the screen, then long tap **Bluetooth**.
 - Navigate to **Settings** > **Basic Settings** > **Bluetooth**.
The phone screen shows the paired and connected Bluetooth device.
2. Tap  after the connected mobile phone name.
3. Tap **Unpair**.

Disconnecting the Bluetooth-enabled Mobile Phone

You can disconnect your Bluetooth-enabled mobile Phone from your phone and still keep it paired. When you disconnect a Bluetooth device, it remains paired so that you can reconnect it to your phone.

Procedure

1. Do one of the following:
 - Tap .
 - Swipe down from the top of the screen, and long tap **Bluetooth**.
 - Navigate to **Settings > Basic Settings > Bluetooth**.
2. Tap the connected mobile phone.
3. Tap **OK**.

Deactivating the Bluetooth Mode

You can deactivate the Bluetooth mode when you no longer use a Bluetooth device.

Procedure

1. Do one of the following:
 - Swipe down from the top of the screen.
 - Tap .
 - From the home screen, navigate to **Settings > Basic Settings > Bluetooth**.
2. Turn off the Bluetooth.

The Bluetooth icon disappears from the status bar.

Wireless Network

The phone can be connected to the wireless network if Wi-Fi is available within the area.

You cannot use a wireless network and Ethernet simultaneously to connect phones to your network. Enabling wireless connectivity automatically disables the Ethernet port.

Note

Enabling Bluetooth may degrade your wireless network connection. For improved wireless network performance, you should disable Bluetooth when it is not in use.

Topics

[Activating the Wi-Fi Mode](#)

[Connecting to the Wireless Network](#)

[Viewing the Wireless Network Information](#)

[Disconnect from a Wireless Network](#)

[Deactivating the Wi-Fi Mode](#)

Related Topic

[Deactivating the Bluetooth Mode](#)

Activating the Wi-Fi Mode

You can activate the Wi-Fi mode to connect your phone to an available wireless network.

Procedure

1. Do one of the following:
 - Swipe down from the top of the screen.
 - Navigate to **Settings** > **Basic Settings** > **Wi-Fi**.
2. Turn on the Wi-Fi.

The phone automatically scans the available wireless networks in your area.

The Wi-Fi icon appears in the status bar.

Connecting to the Wireless Network

After you have activated the Wi-Fi mode, you can connect the phone to the wireless network.

When the phone is connected to a wireless network, the Wi-Fi icon  will display in the status bar.

Topics

[Connecting to an Available Wireless Network Manually](#)

[Connecting to the Wireless Network Using Wi-Fi Protected Setup](#)

[Adding a Wireless Network Manually](#)

Connecting to an Available Wireless Network Manually

You can use the password provided by your system administrator to connect the phone to a secured wireless network.

Before You Begin

Make sure that the Wi-Fi mode is activated.

Procedure

1. Navigate to **Settings > Basic Settings > Wi-Fi**.

The phone will automatically search for available wireless networks in your area.

2. (Optional.) To research the available network, select  > **Scan**.
3. Tap the desired wireless network (SSID) to connect to it.
4. Enter the desired password in the **Password** field.
5. Select **Show password** to make the password visible.
6. Select **Show advanced options** to configure the HTTP proxy for the **Browser**.
7. Tap **Connect**.

Once the connection has completed successfully, the prompt "Connected" appears under the corresponding SSID.

Related Topic

[Activating the Wi-Fi Mode](#)

Connecting to the Wireless Network Using Wi-Fi Protected Setup

You can connect to the wireless network by using the Wi-Fi protected setup (WPS) to make the connection easier.

The WPS provides simplified mechanisms to configure secure wireless networks. WPS can automatically configure a wireless network with a network name (SSID) and strong WPA data encryption and authentication.

There are two supported methods in the Wi-Fi protected setup:

- **Push Button Configuration (PBC):** The user simply has to press the WPS key on both the phone and gateway/router to connect.
- **Personal Identification Number (PIN):** The user enters the PIN generated randomly by the phone on the gateway/router to connect.



Before You Begin

Make sure that the Wi-Fi mode is activated.

Procedure

1. Navigate to **Settings > Basic Settings > Wi-Fi**.

2. Do one of the following:

- Select  > **WPS** to use the PBC method, then long press the WPS key on your gateway or router.
Once WPS setup has completed successfully, the phone screen will prompt "Connected".
- Select  > **WPS-PIN** to use the PIN method, then log into your gateway or router's web interface, and configure it to search the clients. For more information, refer to the documentation from the gateway or router manufacturer.

Once WPS-PIN setup has completed successfully, the web interface of the gateway or router will prompt the connection is successful.

Related Topic

[Activating the Wi-Fi Mode](#)

Adding a Wireless Network Manually

If your gateway/router has SSID broadcast disabled, it doesn't appear in the scanning results. Then you must manually add a wireless network.

Before You Begin

Get the available wireless network information from your system administrator. Make sure that the Wi-Fi mode is activated.

Procedure

1. Navigate to **Settings > Basic Settings > Wi-Fi**.
2. Select **> Add**.
3. Enter the desired value in the **Network SSID** field.
4. Tap the desired value from the **Security** field.
 - If you select **WEP** or **WPA/WPA2 PSK**, enter the password.
 - If you select **802.1x EAP**, tap the desired value from the **EAP method** field, and enter additional information.
5. Select **Show password** to make the password visible.
6. Select **Show advanced options** to configure the HTTP proxy for the **Browser**.
7. Tap **Save**.

Related Topic

[Activating the Wi-Fi Mode](#)

Viewing the Wireless Network Information

You can view the detailed wireless network information, such as Profile Name, SSID and Signal Strength.

Procedure

1. Navigate to **Settings > Basic Settings > Wi-Fi**.
2. Tap **Wireless Status**.
3. (Optional.) Drag up and down to scroll through the list of wireless network information.

Disconnect from a Wireless Network

You can disconnect the wireless network connection from your phone.

Procedure

1. Navigate to **Settings > Basic Settings > Wi-Fi**.
2. Tap the connected SSID (the top one).
3. Tap **Forget**.

Tips

You can also disconnect from the wireless network by deactivating the Wi-Fi mode.

Related Topic

[Deactivating the Wi-Fi Mode](#)

Deactivating the Wi-Fi Mode

You should deactivate the Wi-Fi mode when you need to connect your phone to the wired network.

Procedure

1. Do one of the following:
 - Swipe down from the top of the screen.
 - From the home screen, navigate to **Settings** > **Basic Settings** > **Wi-Fi**.
2. Turn off the Wi-Fi.

The Wi-Fi icon disappears from the status bar.

Maintaining Your Phone

When your phone is unable to operate properly, you need to investigate or troubleshoot issues along with other tasks your system administrator may ask you to perform.

Topics

- [Investigating Warnings](#)
- [Clearing Warning Icon](#)
- [Diagnosing the Network](#)
- [Rebooting Your Phone](#)
- [Resetting to Factory Settings](#)
- [Updating the Phone Configuration](#)
- [Clearing User's Personalized Configuration Settings](#)

Investigating Warnings

A warning icon  is displayed in the status bar to remind you of changing the default password as soon as possible. You can view details about the issue from **Status** screen.

Procedure

1. Navigate to **Settings** > **Status** > **General**.

*The warning detail is displayed in the **Warning** field.*

Related Topic

[Changing the Administrator Password](#)

Clearing Warning Icon

You can temporarily remove the warning icon from the status bar. However, the warning message still is displayed on the **General** screen until the issue is fixed.

The warning icon appears in the status bar again after reboot if the issue is not fixed.

Procedure

1. Navigate to **Settings** > **Status** > **General**.
2. Tap the **Warning** field.

The phone prompts you whether to clear the warning icon.

3. Tap **OK**.

*The warning icon  is removed from the status bar. And it is also removed from the **Warning** field.*

Tips

You can also swipe left or right to temporarily remove the warning icon via Notification Center.

Related Topic

[Control Center and Notification Center](#)

Diagnosing the Network

When network problems occur on your phone, you can use the "ping" or "trace route" method to troubleshoot network connectivity problems.

Procedure

1. Navigate to **Settings > Features > Diagnostics > Network**.
2. Do one of the following:
 - Select **Ping**, then enter the desired IP address or URL in the **Ping IP or URL** field.
 - Select **Trace Route**, then enter the desired IP address or URL in the **Trace Route IP or URL** field.
3. Select **Start**.

The screen displays the network status information.

Rebooting Your Phone

The improper operation may cause malfunction. If the malfunction occurs, your system administrator may ask you to reboot your phone.

Procedure

1. Navigate to **Settings > Basic Settings > Reboot > Reboot**.

The phone prompts you whether to reboot the phone.

2. Select **OK**.

Resetting to Factory Settings

When some issues occur on your phone and you have tried all troubleshooting suggestions but still do not solve the problem, you can reset your phone to factory configurations.

This operation will delete all your personal configuration settings, and reset all settings to the factory defaults. Check with your system administrator if the personalized settings are kept before resetting your phone to factory settings.

Procedure

1. Navigate to **Settings > Advanced Settings** (default password: admin) > **Reset Config**.
2. Select **Reset to Factory Settings**.

The phone prompts you whether to reset the setting.

3. Select **OK**.

The phone begins resetting.

Tips

You can also long tap the left Mute key when the phone is idle.

After reset, the screen "Initializing..."

The phone will be reset successfully after startup.

Note

Reset of your phone may take a few minutes. Do not power off until the phone has started up successfully.

Updating the Phone Configuration

Your system administrator may ask you to update the configuration for your phone to apply any changes to system settings, which you can do without restarting it.

Procedure

1. Navigate to **Settings > Basic Settings > Update Configuration**.
2. Enter the provision information in the corresponding field.
3. Tap  .
The phone prompts you whether to provision now.
4. Tap **OK**.

Clearing User's Personalized Configuration Settings

You can clear the personalized configuration settings manually on the phone.

Before You Begin

Your system administrator has enabled the phone to keep user's personalized settings after auto provisioning.

Procedure

1. Navigate to **Settings > Basic Settings > Reset Local Config > Reset Local Config**.
The phone prompts you whether to reset the local settings.
2. Tap **OK**.

Appendix - Menu Structure

